

STEP 5 **Install the 24 V Transducer Power Supply (continued)**

5.22 Attach the 24V Power Supply cover by aligning the tabs with the mounting slots, seat the front cover into place, and tighten the screw on the front.

Table 1.18 Attach the 24V Power Supply Cover
IP20/NEMA 1, UL Type 1 and IP66/NEMA 4X, UL Type 4X

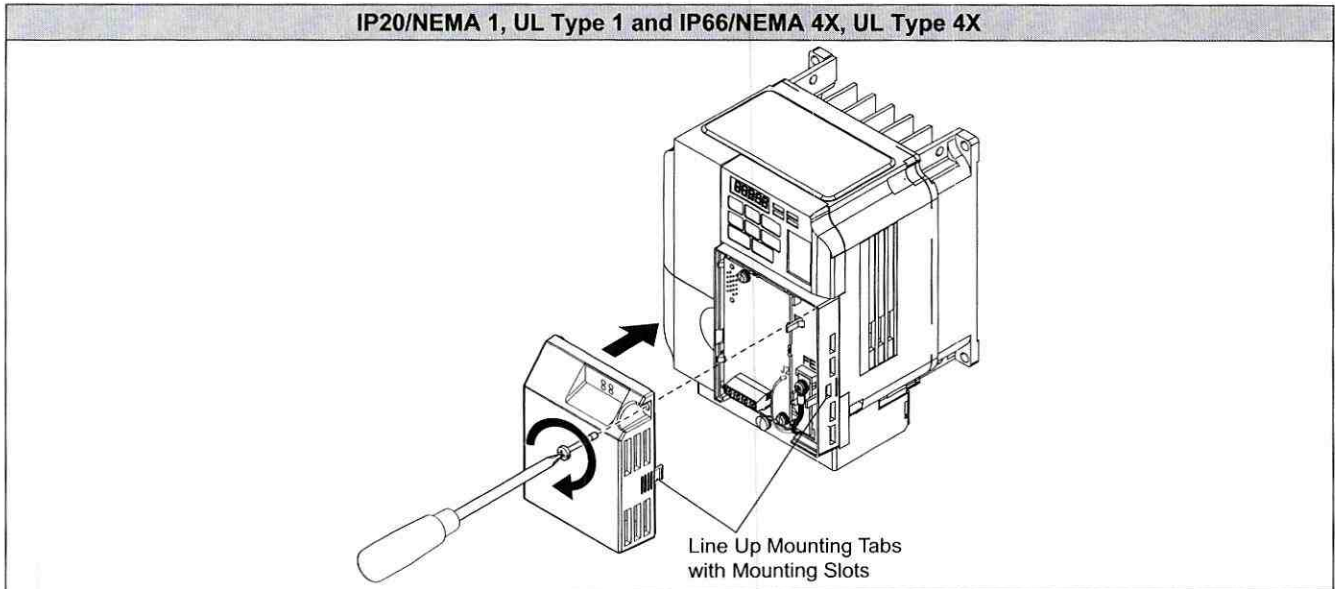

NOTICE: Damage to Equipment. Take proper precautions when wiring the 24V Power Supply unit so that the front covers will easily fit back onto the drive. Make sure no cables are pinched between the front covers and the drive when replacing the cover. Failure to comply may result in damage to circuitry and equipment.

5.23 Secure the shielded cable with a customer-supplied adhesive mount wire tie positioned on the lower drive cover to complete the installation procedure for IP20/NEMA 1, UL Type 1 enclosures.

Table 1.19 Secure the Shielded Cable

IP20/NEMA 1, UL Type 1	IP66/NEMA 4X, UL Type 4X
<p>The diagram shows the lower drive cover with a shielded cable connected. A customer-supplied adhesive mount wire tie is used to secure the cable. Labels indicate 'Slack for Strain Relief' and 'Customer-Supplied Adhesive Mount Wire Tie'. A small diagram of the wire tie is shown below the main diagram.</p>	<p>Not applicable.</p>

STEP 5 □ Install the 24 V Transducer Power Supply (continued)

5.24 On IP66/NEMA 4X, UL Type 4X models, insert the digital operator cable from the front cover into port CN1 on the drive.

Table 1.20 Insert Digital Operator Cable

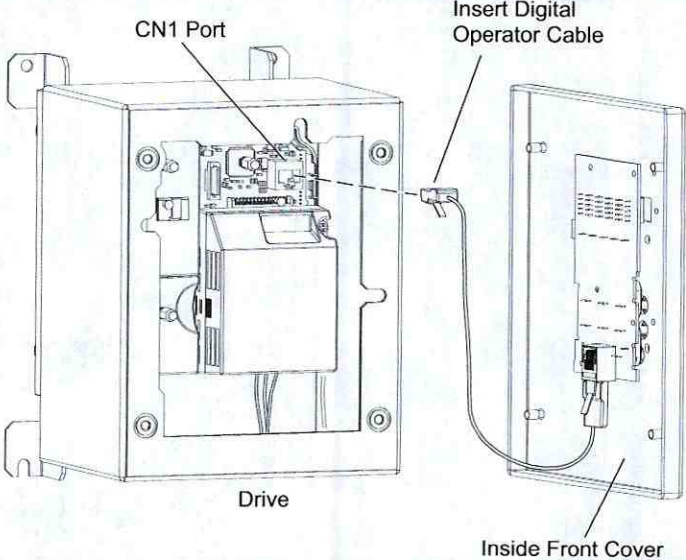
IP20/NEMA 1, UL Type 1	IP66/NEMA 4X, UL Type 4X
Not applicable.	

5.25 To complete the installation procedure on IP66/NEMA 4X, UL Type 4X enclosures, reattach the front cover of the drive enclosure. Refer to **Table 1.22** for tightening torque specifications.

NOTICE: *Damage to Equipment.* Take proper precautions when wiring the 24V Power Supply unit so that the front covers will easily fit back onto the drive. Make sure no cables are pinched between the front covers and the drive when replacing the cover. Failure to comply may result in damage to circuitry and equipment.

Table 1.21 Attach Enclosure Front Cover

IP20/NEMA 1, UL Type 1	IP66/NEMA 4X, UL Type 4X
Not applicable.	

Table 1.22 IP66/NEMA 4X, UL Type 4X Enclosure Front Cover Installation Bolt Size and Tightening Torque

Voltage Class	Drive Model	Installation Screw Size	Tightening Torque N·m (lb-in)
Single-Phase 200 V Class	BV0001G to BV0012G	M5	2.0 to 2.5 (17.7 to 22.1)
Three-Phase 200 V Class	2V0001G to 2V0020G	M5	2.0 to 2.5 (17.7 to 22.1)
	2V0030G to 2V0069G	M6	5.4 to 6.0 (47.8 to 53)
Three-Phase 400 V Class	4V0001G to 4V0011G	M5	2.0 to 2.5 (17.7 to 22.1)
	4V0018G to 4V0038G	M6	5.4 to 6.0 (47.8 to 53)

STEP
6

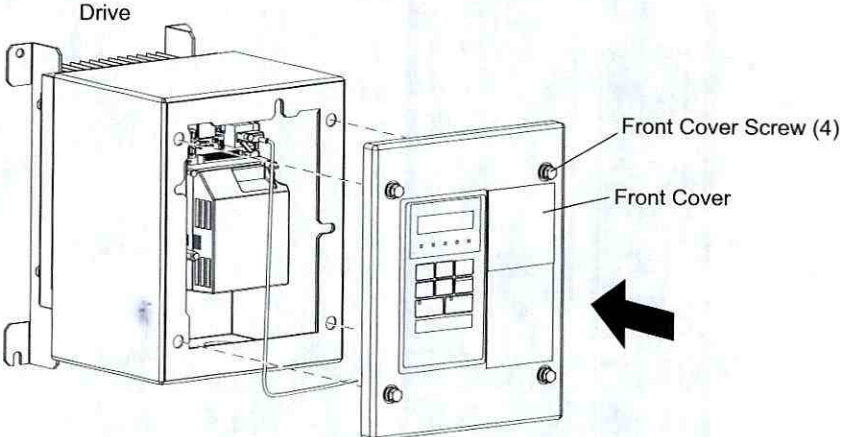

□ Adjust and Monitor iQpump Micro Settings

6.1  Access the Parameter Menu and Change Parameter Values. **DO NOT RUN THE MOTOR.** Ensure all protective covers are installed and power is turned on.

LED Digital Operator (Standard)



iQpump Micro digital operator power-up state



Press  two times until the digital operator shows the parameter menu (PAR) then press .





Select Parameter Menu

Press  to select the digit you would like to change. Next use  and  to select the parameter group, sub-group or number.



Select Parameter

Modify the parameter value using  and  and press  to save the new value.

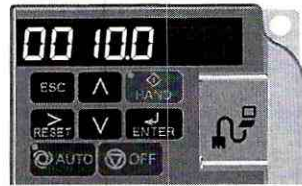

Monitor Motor Frequency and Current (Standard)

iQpump Micro digital operator power-up state



Press  until the FOUT LED turns on. The display now shows the actual drive output frequency in Hz.



Output Frequency

Pressing  again will show the motor output current. The 'A' behind the value means 'Amps'.



Motor Current

Refer to the iQpump Micro User Manual, (Document No. TOEPYAIQPM03) to access additional drive monitors

STEP 7 Application Specific Setup

7.1 **Configure the iQpump Micro for a dedicated pump application. DO NOT RUN THE MOTOR. Ensure all protective covers are installed and power is turned on.**

Available iQpump Micro Application Macro Settings using parameter A1-03 :

- 6008 Constant Pressure Mode (PSI) [Factory Default] **Note: Do not change unless pump application differs from default.**
- 6009 Pump Down Level Mode (Ft)
- 7770 General Purpose Mode
- 7771 Submersible Motor GP Mode

7.2 Select Application Macro Parameter A1-03

LED Digital Operator (Standard)

Press two times until the digital operator shows the parameter menu.



2X → → 2X



→ →

Inc./Dec. Selection Switch to Edit Mode Select Application

Press to select.

Enter Application Parameters (Standard)

Hold button for 3 sec. to go back to the main menu.



3X → →

Select Parameter.



→ →





Switch to Edit Mode Modify Value Save New Value

Go Back to Main Menu (Standard)



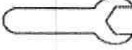

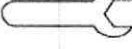
Hold button for 3 sec. to go back to the main menu.

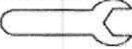
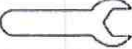
STEP
8

Parameter Overview-Quick Setting Menu (Simplex)

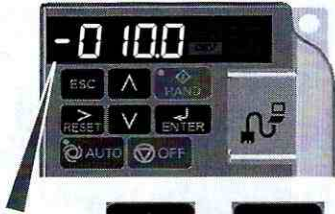
Task	Parameter	Name	Description/Menu Access	Default Value
<p>8.1 Read-only parameter. It cannot be modified. Factory set to (0: Pressure control)</p>	A1-06	Application Preset	<p>Displays selected applications, see Step 5.</p> <p>Quick Setting</p> 	<p>Factory set to (0: Pressure control).</p> <p>Dependent on Initialization Mode</p>
<p>8.2 Set to the motor nameplate full load amps</p> <p>Set service factor amps (SFA) for submersible motors use</p>	E2-01	Motor Rated Current	<p>Motor nameplate full load amps.</p> <p>Quick Setting</p> 	Drive Size Dependent
<p>8.3 Enter '4' for an 1800 RPM motor and '2' for a 3600 RPM motor.</p> <p>Confirm number of poles:</p> <ul style="list-style-type: none"> • 2 Pole Motor = 3600 RPM • 4 Pole Motor = 1800 RPM • 6 Pole Motor = 1200 RPM • 8 Pole Motor = 900 RPM 	E2-04	Number of Motor Poles	<p>Sets the number of motor poles.</p> <p>Number of motor poles is used to show the correct motor RPM on the display</p> <p>Quick Setting</p> 	2
<p>8.4 System Scaling: Enter feedback device maximum:</p> <p>Example: Enter 200 for pressure transducer with a maximum of 200 PSI at 20mA.</p> <p>Confirm feedback device scaling. (See Illustration 1)</p>	P1-03	Feedback Device Scaling	<p>Sets the scaling of feedback device in user-set units.</p> <p>Quick Setting</p> 	145.0
<p>8.5 Set to system pressure</p>	Q1-01	PID Controller Setpoint 1	<p>Sets the PID Setpoint when b1-01 is set to 0.</p> <p>Quick Setting</p> 	0.0
<p>8.6 Choose one of two types of Start Level programming:</p> <p>1. Program the Start Level as an Absolute</p> <p style="text-align: center;">OR</p> <p>2. Program the Start Level as a Delta Level from the System Setpoint</p>	P1-04	Start / Drawn Down Level	<p>The system starts when the feedback level drops below the start level for the time set in P1-05 (default 1 sec). This level also specifies the wakeup level when the drive is in Sleep Mode. When this parameter is set to a negative value, the feedback level must drop that amount below the setpoint. Setting this parameter to 0.0 disables the function. When P1-01, Pump Mode, is set to 3 (MEMOBUS network), this function is active only on the first drive in the network.</p> <p>Quick Setting</p> 	0.0 PSI

STEP 8 **Parameter Overview-Quick Setting Menu (Simplex) continued.**

Task	Parameter	Name	Description/Menu Access	Default Value
<p>8.7 Program the Start Level as an Absolute Value.</p> <p>Start / Draw Down Level must be programmed to a positive value for the Start / Draw Down Level to be an absolute value.</p> <p>Example: Start / Draw Down Level P1-04 set to 50 PSI and delay time P1-05 set to 5 sec. Result: Pump system will start when the pressure drops below 50 PSI for 5 sec.</p>			<p>Important! It is mandatory to program the Start / Draw Down Level in order to use the sleep function.</p> <p>LED Digital Operator (Standard)</p>  <p>Use   to change the sign</p>	
<p>OR</p> <p>Program the Start Level as a Delta Level from the System Setpoint</p> <p>Start / Draw Down Level must be programmed to a negative value for the Start Level to be a delta value from the setpoint.</p> <p>Example: Start / Draw Down Level P1-04 set to -10 PSI with a system setpoint of 50 PSI and delay time P1-05 set to 5 sec. Result: Pump system will start when the pressure drops below 40 PSI (50 - 10) for 5 sec.</p>				
<p>8.8 Set Minimum Pump Frequency to the value at which the pump enters a no-flow condition.</p>	P1-06	Minimum Pump Speed	<p>Minimum speed (Hz) for pump motor operation.</p> <p>Quick Setting</p> 	40.0 Hz
<p>8.9 Recommended for use when the Start/Stop command is from the digital operator</p> <p>WARNING! Sudden Movement Hazard. If the drive is powered down while running, it will automatically initiate an internal Run command upon power-up.</p>	P4-10	AUTO Mode Operator Run Power Down Storage	<p>Stores the run status in the AUTO mode when operating from digital operator (b1-02=0).</p> <p>0: Disabled 1: Enabled</p>	0: Disabled
<p>Optional step: HAND key on digital operator.</p>	P5-04	HAND Key Function Selection	<p>Enables or disables the HAND key on the digital operator.</p> <p>0: Disabled 1: Enabled</p>	1: Enabled

STEP
9

iQpump Micro Parameters - Advanced Settings

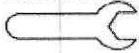
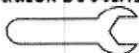
Task	Parameter	Name	Description/Menu Access	Default Value
9.1 NOTICE: Setting value may cause PID control loop instability if misadjusted.	b5-03	Integral Time Setting (I)	Sets the integral time for the PID controller. Decrease integral time to make iQpumpMicro more responsive. Quick Setting 	3.0 sec.
9.2 NOTE: Disable parameter b5-12 if a transducer is not installed.	b5-12	Feedback Loss 4 to 20 mA Detection Selection	Performs a 4 to 20 mA wire break detection on the analog input that is programmed for PID feedback. Terminal TB1-1 A2 (typical) 0: Disabled, continue running, no message is displayed 1: Alarm, display warning on the digital operator when the feedback device fails or is disconnected. 2: Fault, stop the pump system when the feedback fails or is disconnected 3: Run at the setting value of parameter Quick Setting 	2 (Fault)
9.3 Adjust depending on system performance	C1-01	Acceleration Time 1	Sets the time to accelerate the pump motor from zero to maximum speed. NOTE: The factory default with Thrust Mode enabled is 12.0 sec, 20.0 sec when disabled.	20.0 sec. See Note
	C1-02	Deceleration Time 1	Sets the time to decelerate the pump motor from maximum speed to zero. NOTE: The factory default with Thrust Mode enabled is 5.0 sec, 10.0 sec when disabled.	10.0 sec. See Note
9.5 Refer to L5 parameter group. The number of restart attempts is set by L5-01. Configurable iQpump Micro System Protection Faults for Auto-restart: - Low Level Feedback - High Level Feedback - Transducer Loss - Not Maintaining Setpoint - Loss of Prime - Pump Over Cycle.	L5-01	Number of Restart Attempts	Sets the number of times the drive may attempt to restart after these faults occur: <ul style="list-style-type: none"> - oC-Overcurrent - GF-Ground Fault - LF-Output Phase Loss - PF-Input Phase Loss - oL2-iQpumpMicro Overload - oL1-Motor Overload - oL3/4-Overtorque - DC Bus Fuse Blown - Uv1-DC Bus Undervoltage - ov-DC Bus Overvoltage - oH1-Overheat 	5
9.6 P1-06 should be set to the level at which the pump produces minimum pressure even at zero flow. Example: Base pump motor speed is 3600 RPM, minimum speed is 2400 RPM. Set minimum pump frequency to 40.0 Hz. ($2400 \div 3600 \times 60 \text{ Hz} = 40 \text{ Hz}$)	P1-06	Minimum Pump Speed	Minimum frequency at which the drive will run. Applies to both HAND and AUTO modes. NOTE: For minimum pump frequency, the drive will use the highest setting from among P1-06, P4-12 (Thrust Bearing Frequency), or d2-02 (Reference Lower Limit)	40.0 Hz

STEP 9 **iQpump Micro Parameters - Advanced Settings (continued)**

Task	Parameter	Name	Description/Menu Access	Default Value
9.7 Adjust according to system requirements.	P2-03	Sleep Delay Time	Sets the delay time before the drive enters Sleep Mode when the selected signal level (P2-01) falls below the specified sleep level (P2-02).	5 sec.
9.8 Primarily used for submersible pumps. Program P4-12 = 0.0 Hz to disable function when iQpump Micro is used with a centrifugal pump.	P4-12	Thrust Bearing Frequency	Sets the frequency reference used when the thrust bearing function is active. The drive will accelerate to this frequency in the time set to P4-11. The drive will decelerate from the frequency in the time set to P4-13.	30.0 Hz
9.9 Set the amount of time for the drive to delay starting if a Run command is present at power-up. Note: Utility Star Delay is active when P4-10 is enabled (1) and operation (start/stop) is from the digital operator.	P4-17	Utility Start Delay	Sets the amount of time that the drive will delay starting if a Run command is present at power-up. When P1-01, Pump Mode, is set to 3 (MEMOBUS network), the drive is unavailable to the network (Pump Off Network) when the function is active. The iQpump Micro waits the time specified in P4-11 before auto operation becomes active when utility power is restored and P4-10 is enabled (1).	0.2 Min Setting this parameter to 0.0 disables the function.

STEP 10 **Fine-tune Settings for Pumping Application**

10.1 SYSTEM FEEDBACK UNIT / FEEDBACK DEVICE SCALING

P1-02 Feedback Unit

- 0: No Unit
- 1: PSI: lb.SqrInch
- 2: Pa: Pascals
- 3: Bar
- 4: WC: Inch Water
- 5: "Hg: Inch Mercury
- 6: ft: Feet
- 7: m: meters
- 8: °F: DegFahrenheit
- 9: °C: DegCelsius
- 10: %: Percent

P1-03 = 200.0 PSI Feedback Scaling

Feedback Maximum

10.2 START / DRAW DOWN LEVEL
Example: Absolute Level (Positive Start Level)

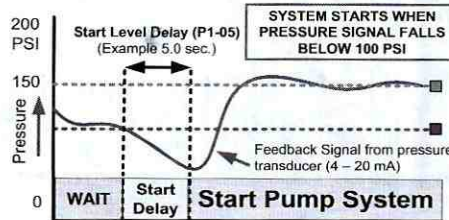

System Setpoint (Example 150.0 PSI)
System Units (P1-02) (Example PSI)
Feedback Scaling (P1-03) (Example 200.0 PSI)
Start / Draw Down Level (P1-04) (Example 100.0 PSI)

START / DRAW DOWN LEVEL
Example: Delta Level (Negative Start Level)

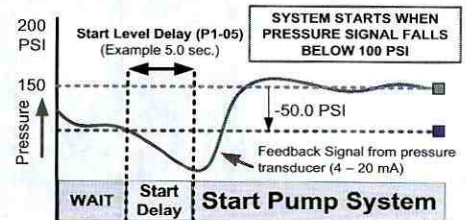

System Setpoint (Example 150.0 PSI)
System Units (P1-02) (Example PSI)
Feedback Scaling (P1-03) (Example 200.0 PSI)
Start / Draw Down Level (P1-04) (Example -50.0 PSI, (150.0 - 50.0))

STEP 10

□ Fine-tune Settings for Pumping Application (continued)

10.3 SLEEP MODE (Example)

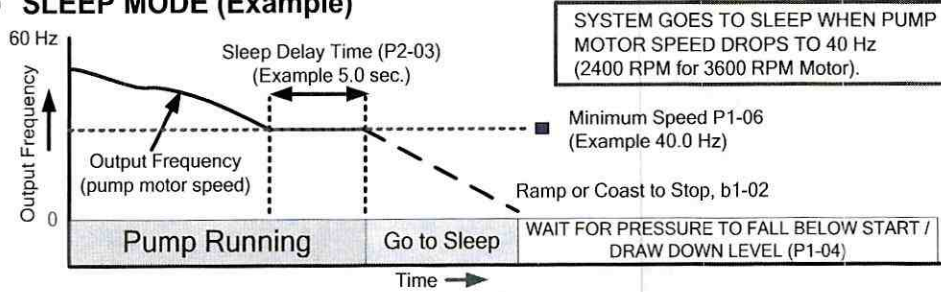

10.4 PUMP SYSTEM FAULT SETUP

The iQpump Micro can display a 'Setpoint Not Met' fault when the iQpump Micro is unable to maintain the programmed system setpoint due a problem with the pump system. Set P1-15 to the maximum allowed difference between setpoint and feedback level.

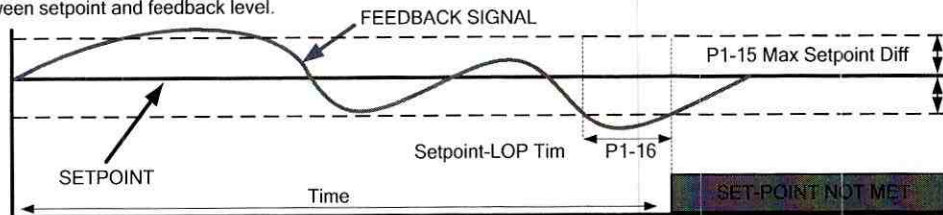

10.5 LOW/HIGH FEEDBACK LEVEL DETECTION

The iQpump Micro continuously monitors the system feedback signal. Set the low feedback level parameter P1-08 to the minimum feedback level allowed for your system to display a 'Low Feedback' fault. Set the high feedback level parameter P1-11 to the maximum feedback level allowed to display a 'High Feedback' fault.

10.6 PRE-CHARGE OPERATION

This function is used when the pump system requires a pre-charge before normal operation. Upon start the iQpump Micro will run at a fixed speed for a specified time or until the feedback signal reaches a programmed level after which it will switch to auto mode operation.

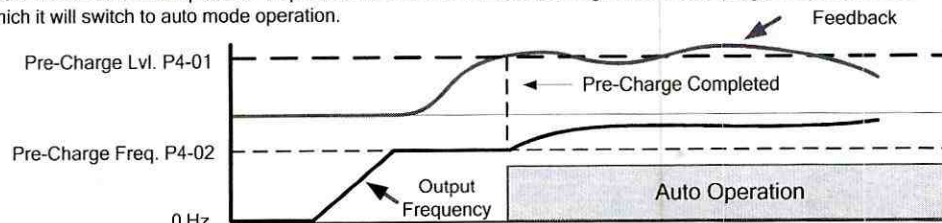

P4-01 Pre-Charge Level: Specified feedback level to stop pre-charge operation
P4-02 Pre-Charge Frequency: Set desired pre-charge speed
P4-03 Pre-Charge Time: Specified maximum pre-charge operation time

10.7 THRUST BEARING - SUBMERSIBLE MOTORS

The factory recommends using the Thrust Bearing function to prevent excess motor wear when using a submersible motor in combination with the iQpump Micro. Enter the minimum motor frequency in parameter P4-11 to enable this function. Example: Minimum motor speed 1800 RPM, $1800 \text{ RPM} \div 3600 \text{ RPM} \times 60.0 \text{ Hz} = 30.0 \text{ Hz}$

Thrust Acceleration Time P4-11
(Example 1.0 sec.) **DEFAULT SETTING**
Thrust Bearing Frequency P4-12
(Example 30.0 Hz)

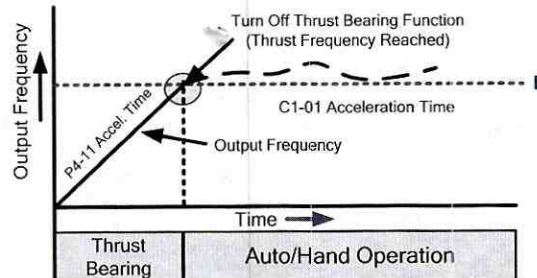

10.8 AUTO OPERATION - POWER DOWN STORAGE

Allows the iQpump Micro to automatically start after power failure when operated from the digital operator. This function is recommended when operating the iQpump Micro in remote/unmanned areas.

Use parameter P4-10 to enable this function.

⚠ WARNING! Stay Clear- Equipment starts automatically. An internal run command will automatically occur on power-up if the iQpump Micro is powered down while running.

STEP 11 **Verify Pump Rotation and Transducer Feedback**

11.1 Check the motor for proper direction and operation.

This test is performed solely from the digital operator. Apply power to the iQpump Micro after electrical connections are terminated and protective covers are installed. At this point, **DO NOT RUN THE MOTOR**, The digital operator should display as shown in Figure 3.

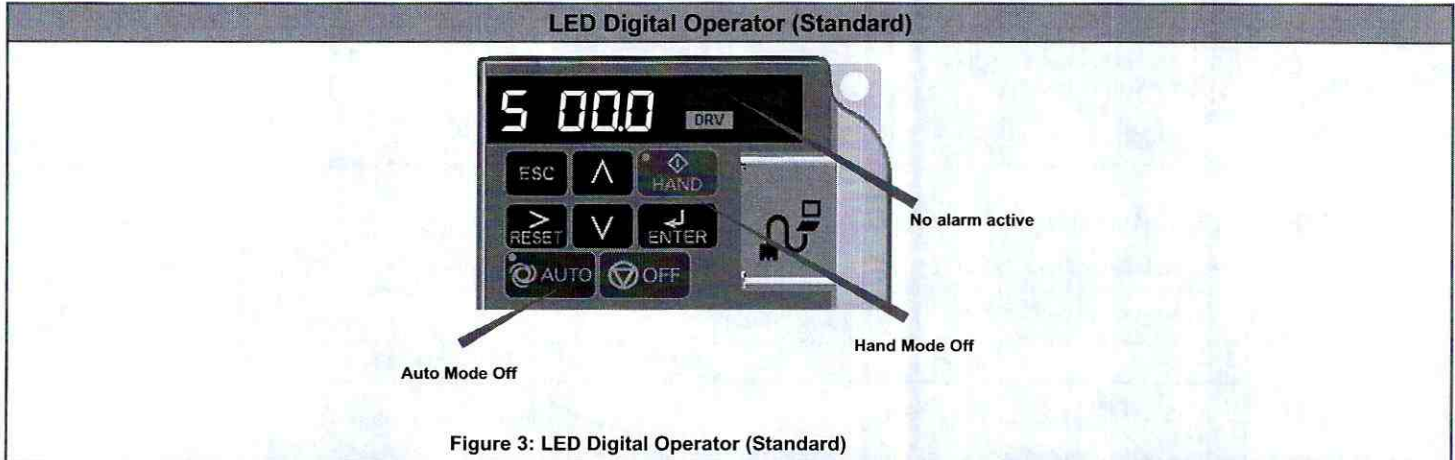

Figure 3: LED Digital Operator (Standard)

11.2 Motor Rotation Test (Standard)

Press on the digital operator; the display should read



and the **HAND** LED should be **ON**.

The motor should be operating in the correct direction of pump.

Press on the digital operator; the display should read as in Figure 3.

Press to access Hand Speed. Use to change HAND Speed value. Press to save value.

NOTE: If the motor direction is not correct, de-energize the iQpump Micro and follow instructions below.

WARNING! Hazardous Voltage. Contact may cause electric shock or burn. Turn-off and lock-out system and facility power before servicing. After the power has been turned OFF, wait at least five minutes until the charge indicator extinguishes completely before touching any wiring, circuit boards or components.



Digital operator turned off.

Refer to **STEP 3**, exchange any **two** of the **three** output leads to the motor (U/T1, V/T2 and W/T3). Recheck motor direction after the wiring change.

11.3 Feedback Signal Check (Standard)

Verify the transducer feedback signal level on the digital operator display matches a mechanical pressure gauge.



From HOME screen, press to access "FEEdb" screen. "FEEdb" will display for 2 seconds, then automatically change to display the feedback signal level.

FEEDBACK SIGNAL LEVEL

STEP 12 **AUTO Mode Operation**

12.1 AUTO Mode

The iQpump Micro is operated in AUTO mode by performing the following tasks: Program all parameters

- Verify motor rotation direction
- Auto Mode: Select the **Reference source** setting in parameter b1-01
- Auto Mode: Select the **Run source** setting in parameter b1-02 (Refer to STEP 4)

LED Digital Operator (Standard)

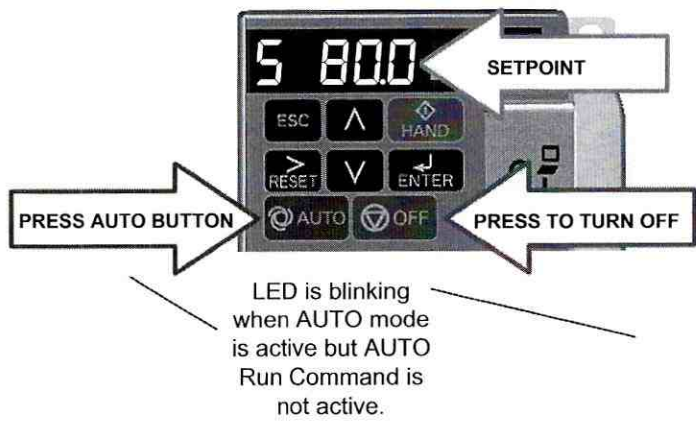

Figure 4: Digital Operator

Press the **AUTO** button to place the iQpump Micro into AUTO mode.

The AUTO mode will start and stop based on the Run Source Selection setting parameter b1-02. (Refer to Step 3) The Reference Source Selection parameter b1-01 setting configures the AUTO mode reference source.

12.2 Set System Setpoint

LED Digital Operator (Standard)

Press **ENTER** to access or modify the system setpoint in parameter Q1-01 within the iQpump Micro Quick Setup Menu.

iQpump Micro Quick Setup Menu. Use **RESET** to select the digit and **UP** **DOWN**. Next press **ENTER** to store setpoint.

Next press **ENTER** to store setpoint.

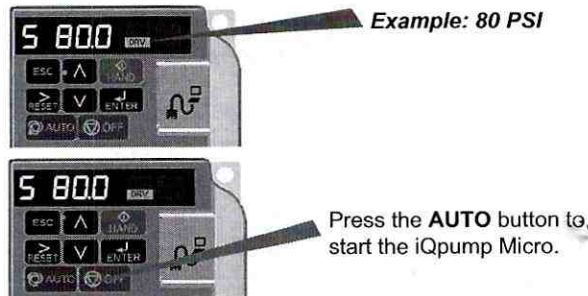

The iQpump Micro starts in AUTO Mode when the feedback signal level falls below the level programmed in parameter P1-04 for the specified time in P1-05.

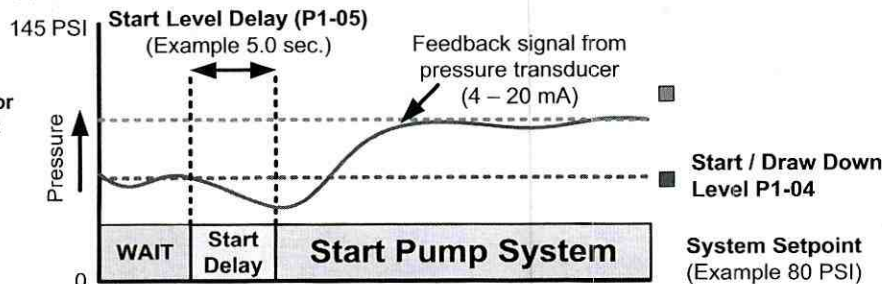

Refer to STEP 8, parameter P1-04 for details on the Start Level Function.

System Setpoint
(Example 80 PSI)

STEP 13 **Hand Mode Operation**

13.1 HAND Mode

The iQpump Micro is operated in HAND mode by performing the following tasks:

- Program all parameters
- Verify motor rotation direction

LED Digital Operator (Standard)

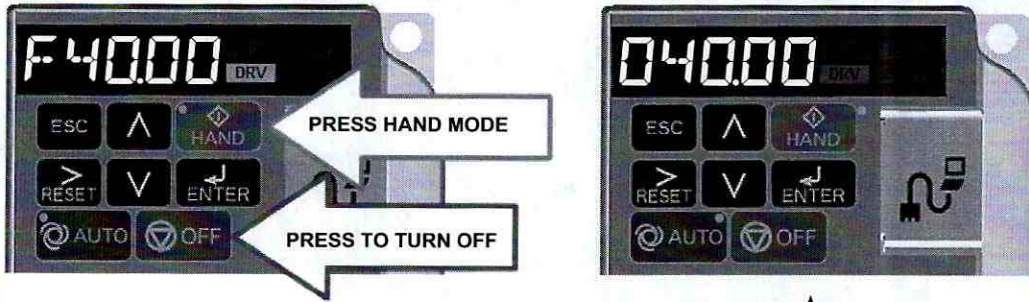

0 to 10 Vdc Connection

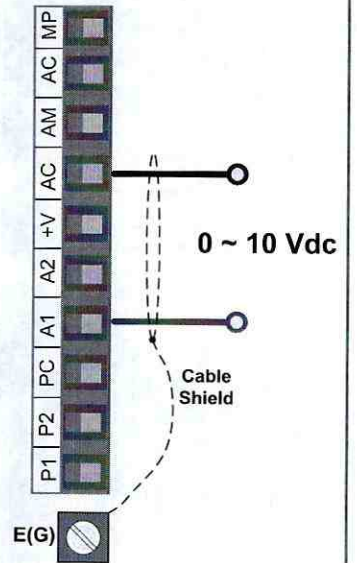

Press to access HAND Speed. Use to change HAND Speed value.

Press to save value.

Hand Speed Reference from Analog Input (0 to 10 Vdc)

Set parameter P5-01 'HAND Mode Ref.' to '0' to adjust the hand mode reference from an external 0 – 10V signal connected to terminals TB1-1, A1 and AC.

NOTES:

Lined area for notes.

iQpump Micro AC Drive

Compact Intelligent Pump Controller

Quick Start Procedure

YASKAWA AMERICA, INC.

2121, Norman Drive South, Waukegan, IL 60085, U.S.A.
Phone: 1-800-YASKAWA (927-5292) or 1-847-887-7000 Fax: 1-847-887-7310
<http://www.yaskawa.com>

DRIVE CENTER (INVERTER PLANT)

2-13-1, Nishimiyaichi, Yukuhashi, Fukuoka, 824-8511, Japan
Phone: 81-930-25-3844 Fax: 81-930-25-4369
<http://www.yaskawa.co.jp>

YASKAWA ELECTRIC CORPORATION

New Pier Takeshiba South Tower, 1-16-1, Kaigan, Minatoku, Tokyo, 105-6891, Japan
Phone: 81-3-5402-4502 Fax: 81-3-5402-4580
<http://www.yaskawa.co.jp>

YASKAWA ELÉTRICO DO BRASIL LTDA.

777, Avenida Piraporinha, Diadema, São Paulo, 09950-000, Brasil
Phone: 55-11-3585-1100 Fax: 55-11-3585-1187
<http://www.yaskawa.com.br>

YASKAWA EUROPE GmbH

185, Hauptstraße, Eschborn, 65760, Germany
Phone: 49-6196-569-300 Fax: 49-6196-569-398
<http://www.yaskawa.eu.com>

YASKAWA ELECTRIC KOREA CORPORATION

9F, Kyobo Securities Bldg., 26-4, Yeouido-dong, Yeongdeungpo-gu, Seoul, 150-737, Korea
Phone: 82-2-784-7844 Fax: 82-2-784-8495
<http://www.yaskawa.co.kr>

YASKAWA ELECTRIC (SINGAPORE) PTE. LTD.

151, Lorong Chuan, #04-02A, New Tech Park, 556741, Singapore
Phone: 65-6282-3003 Fax: 65-6289-3003
<http://www.yaskawa.com.sg>

YASKAWA ELECTRIC (THAILAND) CO., LTD.

252/125-126, 27th Floor, Muang Thai-Phatra Tower B, Rachadapisek Road, Huaykwang, Bangkok, 10310, Thailand
Phone: 66-2693-2200 Fax: 66-2693-4200
<http://www.yaskawa.co.th>

YASKAWA ELECTRIC (CHINA) CO., LTD.

22F, One Corporate Avenue, No.222, Hubin Road, Shanghai, 200021, China
Phone: 86-21-5385-2200 Fax: 86-21-5385-3299
<http://www.yaskawa.com.cn>

YASKAWA ELECTRIC (CHINA) CO., LTD. BEIJING OFFICE

Room 1011, Tower W3 Oriental Plaza, No. 1, East Chang An Ave.,
Dong Cheng District, Beijing, 100738, China
Phone: 86-10-8518-4086 Fax: 86-10-8518-4082

YASKAWA ELECTRIC TAIWAN CORPORATION

9F, 16, Nanking E. Rd., Sec. 3, Taipei, 104, Taiwan
Phone: 886-2-2502-5003 Fax: 886-2-2505-1280

YASKAWA INDIA PRIVATE LIMITED

#17/A, Electronics City, Hosur Road, Bangalore, 560 100 (Karnataka), India
Phone: 91-80-4244-1900 Fax: 91-80-4244-1901
<http://www.yaskawaindia.in>

YASKAWA AMERICA, INC.

In the event that the end user of this product is to be the military and said product is to be employed in any weapons systems or the manufacture thereof, the export will fall under the relevant regulations as stipulated in the Foreign Exchange and Foreign Trade Regulations. Therefore, be sure to follow all procedures and submit all relevant documentation according to any and all rules, regulations and laws that may apply.

Specifications are subject to change without notice for ongoing product modifications and improvements.

© 2014-2015 YASKAWA AMERICA, INC. All rights reserved.



YASKAWA

iQpump Micro AC Drive Compact Intelligent Pump Controller Quick Start Procedure

Type: CIMR-PW

Models: 200 V Class, Single-Phase Input: 1 to 5 HP ND
200 V Class, Three-Phase Input: 1.5 to 25 HP ND
400 V Class, Three-Phase Input: 1 to 25 HP ND

To properly use the product, read this manual thoroughly and retain for easy reference, inspection, and maintenance. Ensure the end user receives this manual.

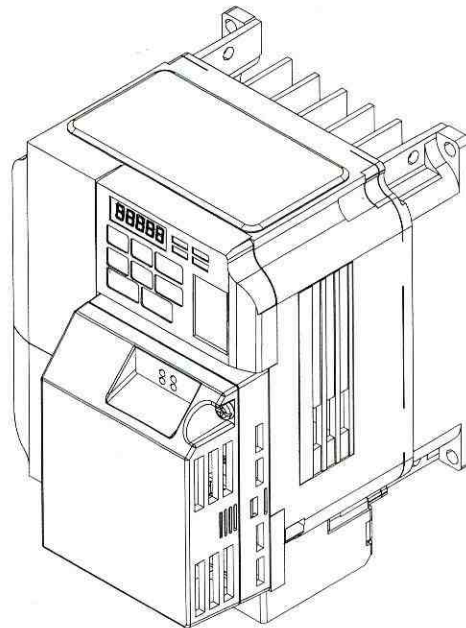

Contents

STEP 1: UNPACK THE IQPUMP MICRO3

STEP 2: IDENTIFY THE MODEL FOR INSTALLATION.....4

STEP 3: PERFORM MECHANICAL INSTALLATION.....5

STEP 4: MOTOR, LINE POWER AND START/STOP CIRCUIT6

STEP 5: INSTALL THE 24 V TRANSDUCER POWER SUPPLY7

STEP 6: ADJUST AND MONITOR IQPUMP MICRO SETTINGS19

STEP 7: APPLICATION SPECIFIC SETUP20

STEP 8: PARAMETER OVERVIEW-QUICK SETTING MENU (SIMPLEX).....21

STEP 9: IQPUMP MICRO PARAMETERS - ADVANCED SETTINGS23

STEP 10: FINE-TUNE SETTINGS FOR PUMPING APPLICATION24

STEP 11: VERIFY PUMP ROTATION AND TRANSDUCER FEEDBACK26

STEP 12: AUTO MODE OPERATION.....27

STEP 13: HAND MODE OPERATION.....28

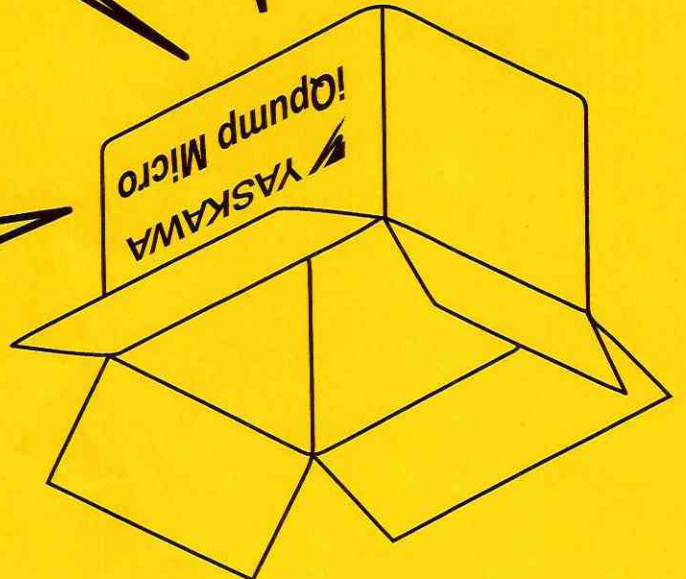
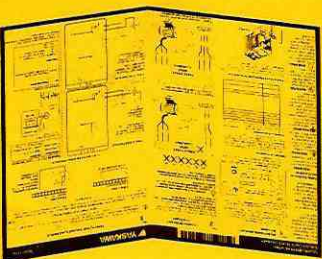
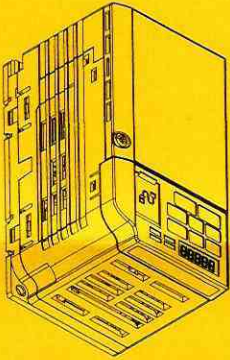
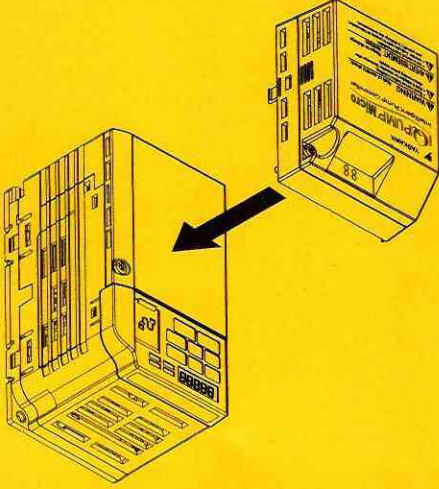

STEP
1

Unpack the iQpump Micro

1 Remove all contents
prior to discarding packaging !

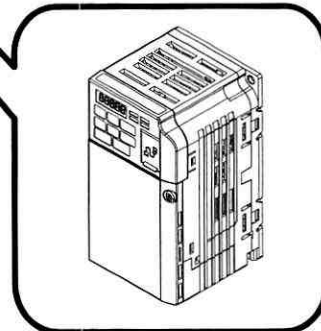
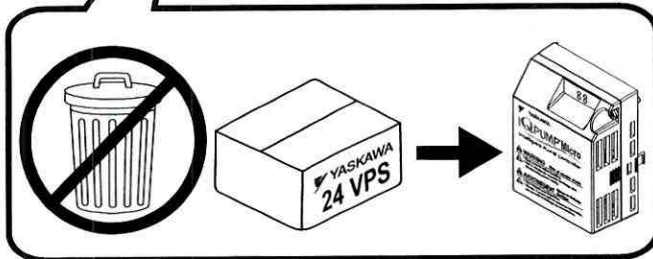
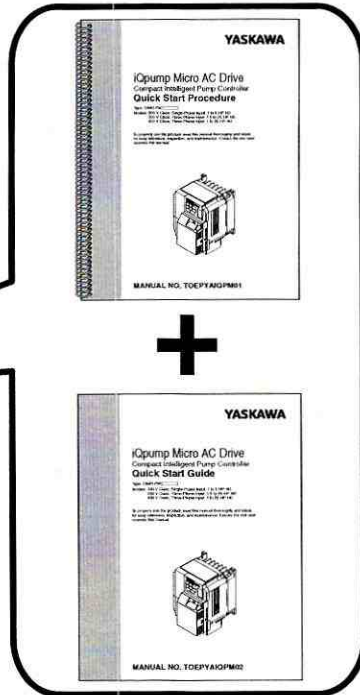
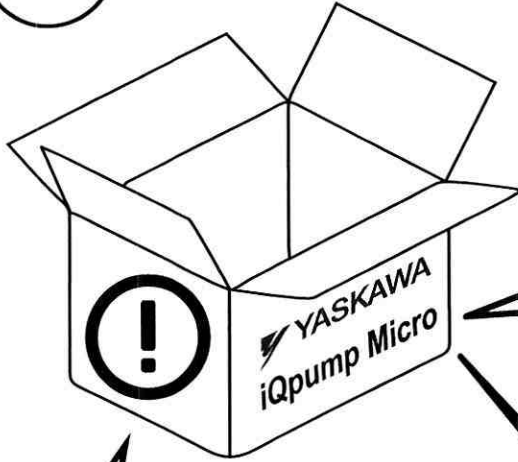

NOTICE: Connect **LINE**, **MOTOR**, and **CONTROL** circuit wiring **BEFORE** installing 24V power supply.

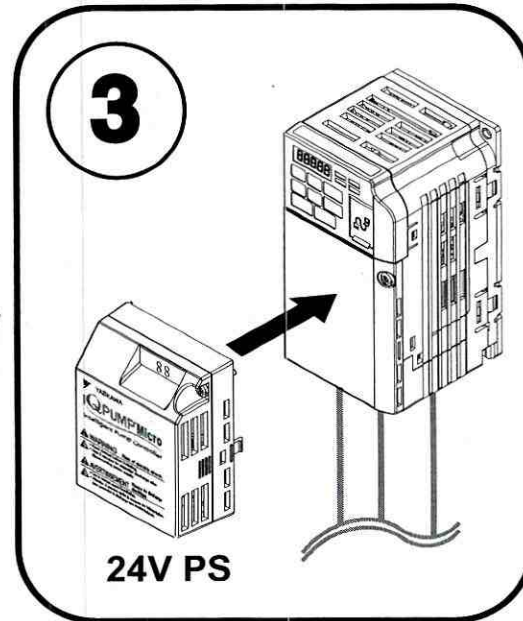
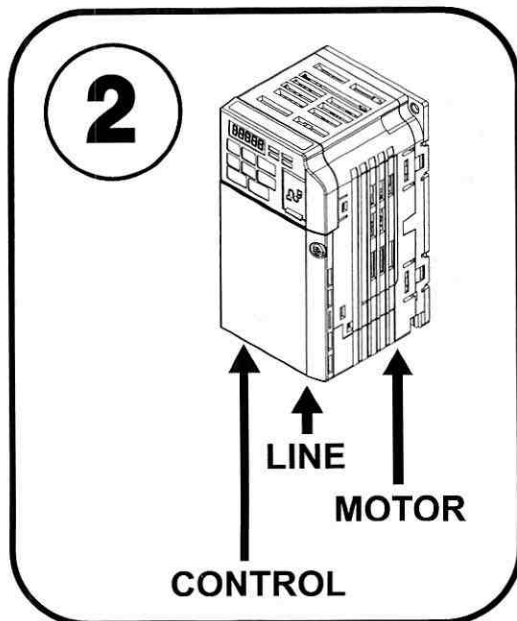

STEP 2 **Identify the Model for Installation**

Safety Symbols in this Document

WARNING!
Read and understand users manual before using this equipment. Failure to follow users instructions may result in serious injury or death.

WARNING!
Hazardous Voltage. Contact may cause electric shock or burn. Turn-off and lock-out system and facility power before servicing.

WARNING!
Stay Clear- Equipment starts automatically. Clear all personnel from equipment, install shields or guards, locate and verify emergency SHUT-OFF is functional. Failure to comply may result in serious injury to personnel.

WARNING!
Improper Operation Sequence. DO NOT RUN THE MOTOR. Failure to comply may result in serious injury to personnel.

WARNING!
Do not operate equipment with covers or guards removed. Install or replace cover and/or guards before operation. Failure to comply may result in serious injury to personnel.

This Quick Start Procedure serves as general guide to help install, configure and perform test run operation. Refer to the iQpump Micro User Manual No. TOEP YAIQPM 03 for complete instructions to configure this product for each specific installation site.

2.1 Verify the correct model and ratings.

Follow this procedure for each iQpumpMicro and motor combination.

- Locate the nameplate and your order information.
- Verify the Model No: (E) matches the line item(s) on your order, to confirm receipt of the correct model.
- Locate the nameplate of motor that will be connected.
- Confirm the motor nameplate Amperage, Voltage, and Frequency (Hz) are within the Output specifications (B) shown on the iQpump Micro nameplate.

2.2 Verify main power source is adequate by reviewing the Input specifications (A) shown on the iQpump Micro nameplate.

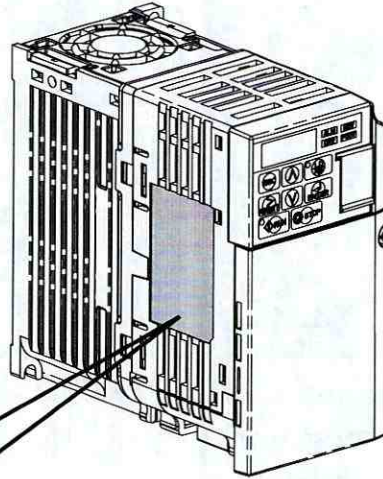

Output Power Rating	MODEL : CIMR-PW□□□□□□□□	UL LISTED	Output Amps
Input Power Rating	MAX APPLI. MOTOR : 0.75kW / 0.4kW REV : A	IND. CONT. EQ.	
Output Power Rating	INPUT : AC3PH 200-240V 50 / 60Hz 2.7A / 1.4A	7J48	
Weight	OUTPUT : AC3PH 0-240V 0-400Hz 1.2A / 0.8A	CE	
Serial Number	MASS : 0.6 kg PRG : □□□□	TUV SUD	Software Version
UL File Number	O / N : S / N :	PASS	
	FILE NO : E131457 IP20	RoHS	

YASKAWA ELECTRIC CORPORATION MADE IN JAPAN
2-1 Kurosaki-shiroishi, Yahatanishi-Ku, Kitakyushu 806-0004 Japan

STEP 3 **Perform Mechanical Installation**

3.1 Verify installation environment.

Mechanical installation and mounting footprint vary by model. Refer to the iQpump Micro User Manual No. TOEP YAIQPM 03, Chapter 2: Mechanical Installation for details. Ensure the installation conditions are suitable to prolong and optimize performance life.

Environment	Conditions
Installation Area	Indoors
Ambient Temperature	-10 to + 40 °C (+14 to +104 °F) NEMA 1, UL Type 1 Enclosure
Humidity	95% RH or less and free of condensation
Storage Temperature	-20 °C to +60 °C (-4 °F to +104 °F)
Surrounding Area	Install the drive in an area free from: <ul style="list-style-type: none"> • oil mist and dust • metal shavings, oil, water, or other foreign materials • radioactive materials • combustible materials (e.g., wood) • harmful gases and liquids • excessive vibration • chlorides • direct sunlight.
Altitude	Up to 1000 meters without derating. Up to 3000 meters with output current and voltage derating
Orientation	Install the unit vertically to maintain maximum cooling effects.

3.2 Maintain installation clearances.

Single Drive Installation

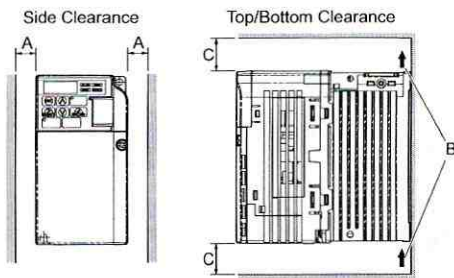

Ensure the back panel is placed against a closed flat surface for proper cooling.

NOTICE: Abnormal Operation. Avoid placing peripheral devices, transformers, or other electronics near the bypass as the noise created can lead to abnormal operation. Take proper steps to shield the bypass from electrical interference if such devices must be used in close proximity to the Bypass.

Multiple Drive Installation

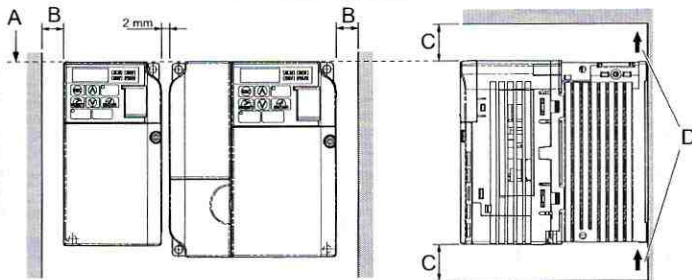

NOTICE: Equipment Damage. Prevent foreign matter such as metal shavings and wire clippings from falling into the bypass during installation. Failure to comply could result in damage to the bypass. Place a temporary cover over the top of the drive during installation. Remove the temporary cover before bypass start-up, as the cover will reduce ventilation and cause the bypass to overheat.

Install Type	Minimum Spacing			
	A	B	C	D
Single drive	30 mm (1.18 in)	<ul style="list-style-type: none"> • Airflow direction 	100 mm (3.93 in)	-
Multiple drive installation	Align the tops of the units	30 mm (1.18 in)	100 mm (3.93 in)	Airflow direction

STEP 4 □ **Motor, Line Power and Start/Stop Circuit**

4.1 ⚠️ 🔧 **Remove the front cover**

NEMA 1, UL Type 1 Enclosure

NOTICE: Improper removal of the the drive's protective covers and conduit bracket (NEMA 1, UL Type 1) can cause damage to the drive. Adhere to iQpump User Manual, Section 3, Protective Covers to avoid drive damage.

4.2 ⚠️ 🔌 **Connect main input power and motor wiring to the drive.**

Refer to **Figure 1** for single-phase input power drive models.
Refer to **Figure 2** for three-phase input power drive models.

Follow accepted wiring practices and applicable electric codes. Ensure all equipment is properly grounded.

WARNING! Fire Hazard. Do not connect terminals B1, B2 (-), +1, +2 terminals to earth ground. Only connect ground wiring to designated ground terminals.

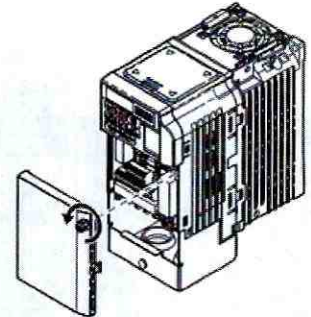
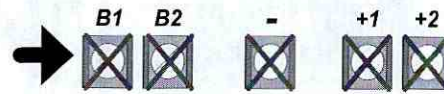
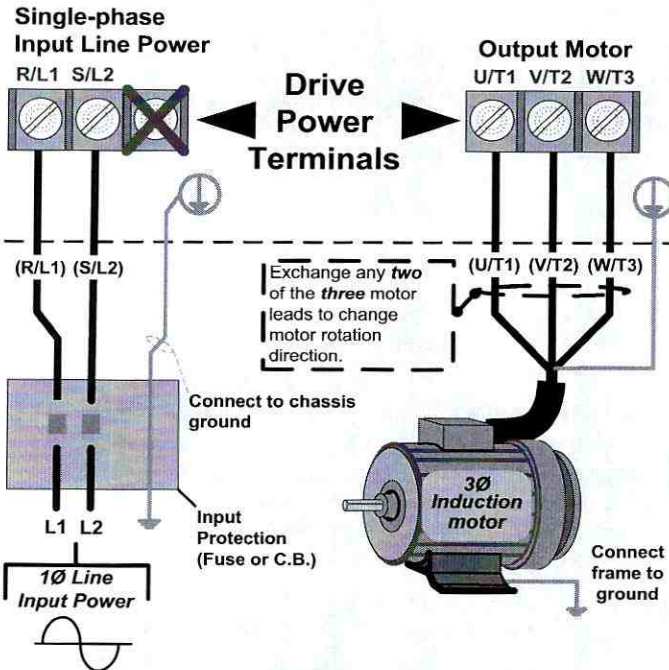
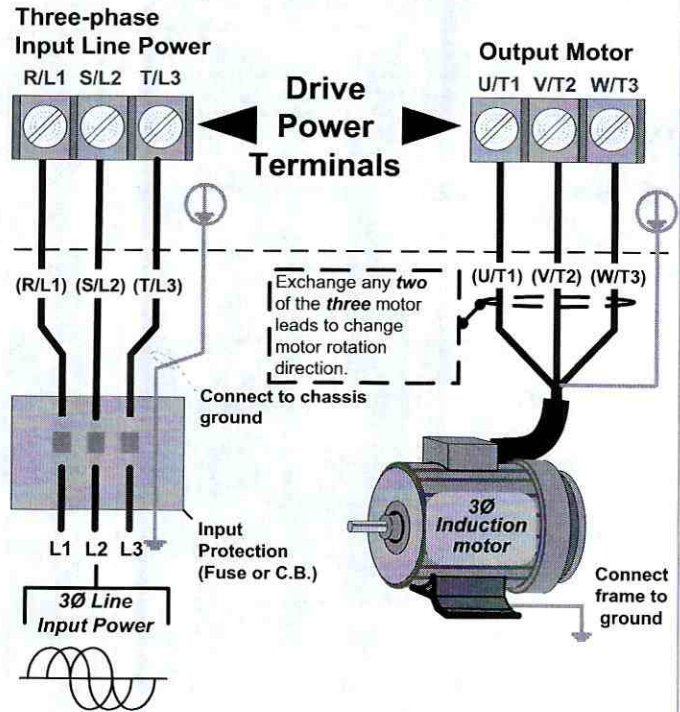

Figure 1: Line and Motor Electrical Connections - Single-Phase Input Power



Sizing note: Verify the drive is properly sized for single phase input power. The drive input line voltage must be equal to or greater than motor rated voltage for best performance.

Figure 2: Line and Motor Electrical Connections - Three-Phase Input Power



4.3 ⚠️ 🔧 **Select start / stop control method, (parameter b1-02).** Remove the drive terminal cover to access the control terminals. The drive will START and STOP from the keypad from the factory. If this is the preferred start/stop method then continue to the feedback signal connection section. Refer to the wiring diagram below to START/STOP the drive using an external switch or contact

2-Wire Start/Stop Wiring Diagram

2-Wire Control

iQpump Micro Terminals TB1-1



Forward Run

Use for maintained contacts

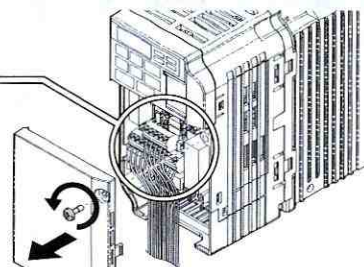

STEP 5 □ Install the 24 V Transducer Power Supply

5.1 24V Power Supply Components

Unpack the 24 V Power Supply

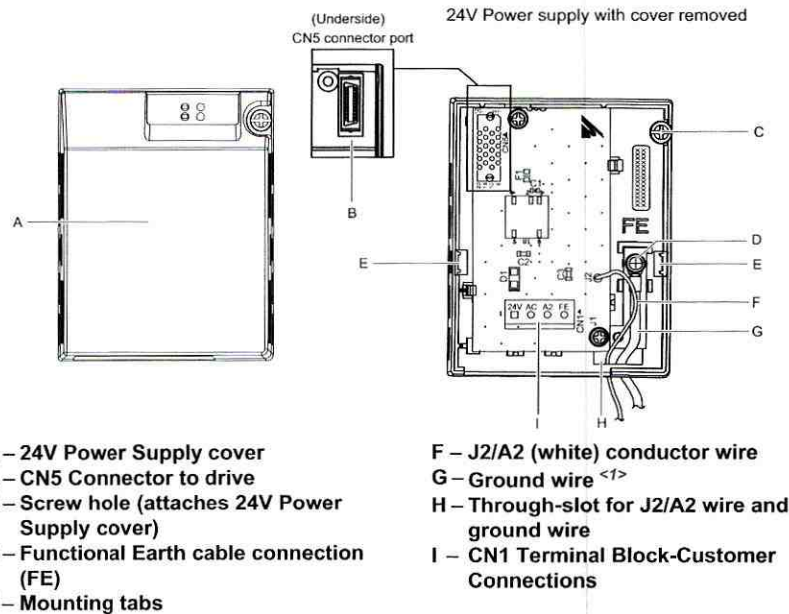
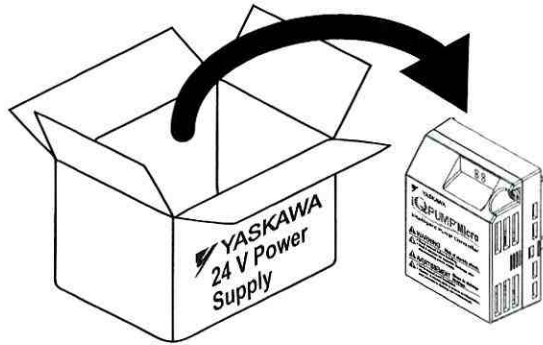

Figure 1.1 24V Power Supply Components

<1> One of the four ground wires packaged with the 24V Power Supply must be connected during installation.

IP20/NEMA 1, UL Type 1 Dimensions with 24V Power Supply

The installed 24 V power supply option adds 27 mm (1.06 in.) to the total depth of the drive. Height and width dimensions are unaffected.

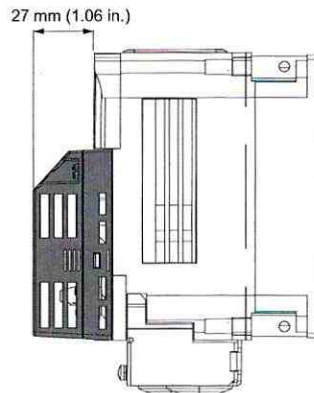

Figure 1.2 24 V Power Supply Dimensions

STEP 5 Install the 24 V Transducer Power Supply (continued)

5.2 Prior to Installing the 24V Power Supply

Prior to installing the 24V Power Supply, wire the drive, make necessary connections to the drive terminals, and verify that the drive functions normally without the 24V Power Supply installed. Refer to the product manual packaged with the drive for information on wiring and connecting the drive.

The installation procedure differs slightly depending on enclosure type. The enclosure type is identified within the drive model number.

5.3 Locate the drive model number using *Figure 1.3*.

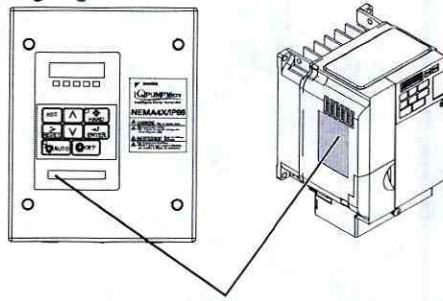

Model Number Location

Figure 1.3 Model Number Location

5.4 Identify the drive enclosure type. Use *Figure 1.4* to find the digit within the model number that identifies the enclosure type.

Note: Installing the 24V Power Supply on an IP20/NEMA 1, UL Type 1 enclosure drive voids NEMA 1, UL Type 1 protection while maintaining IP20 conformity.

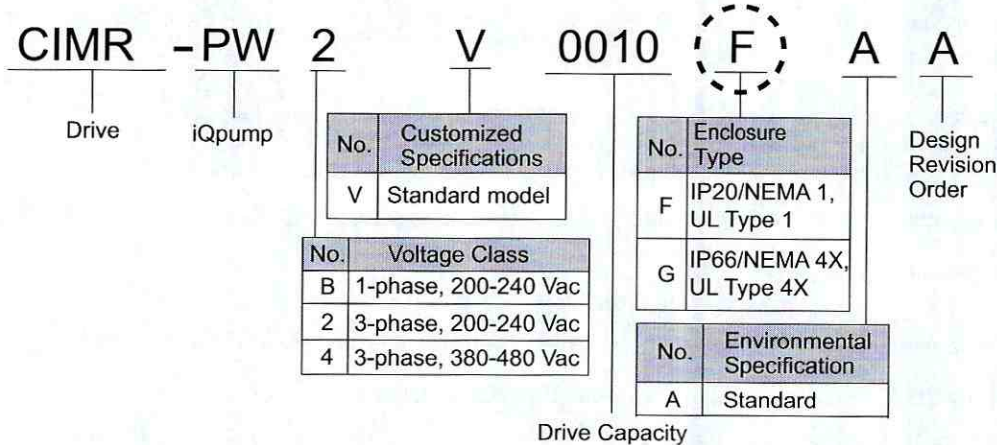

Figure 1.4 Drive Enclosure Type Identification

5.5 Select proper installation tools according to enclosure type and model.

Note: Tools required to prepare the 24V Power Supply cables for wiring are not listed in this manual.

Table 1.1 Tool and Material Requirements (Customer Supplied)

Model Number Enclosure Type Digit	Drive Enclosure Type	Drive Capacity	Tools		Materials
			Screwdriver	Socket Wrench	Wire Tie with Adhesive Mount
F	IP20/NEMA 1, UL Type 1	All	Phillips screwdriver M3 metric	Not applicable	All models
G	IP66/NEMA 4X, UL Type 4X	2V0030 to 2V0069 4V0018 to 4V0038	#1, #2 U.S. standard size Note: Screw sizes vary by drive capacity. Select a screwdriver appropriate for the drive capacity.	10 mm socket wrench	Not applicable
		Other capacities		8 mm socket wrench	

STEP
5

□ Install the 24 V Transducer Power Supply (continued)

5.6 Installation Procedure

5.7 Shut off power to the drive. Wait at least five minutes after confirming the DC bus voltage is safe.

On **IP20/NEMA 1, UL Type 1** models, loosen the screw that fastens the front cover in place and remove the front cover. This drive front cover will be replaced by the 24V Power Supply cover. Cover removal varies depending on drive size.

On **IP66/NEMA 4X, UL Type 4X** models, loosen the 4 bolts that attach the enclosure front cover in place, gently move the front cover away from the enclosure, press firmly on the digital operator cable connector release tab to disconnect the cable from port CN1 on the drive, then remove the front cover. Refer to **Table 1.3** for installation bolt size.

Table 1.2 Remove the Drive or Enclosure Front Cover

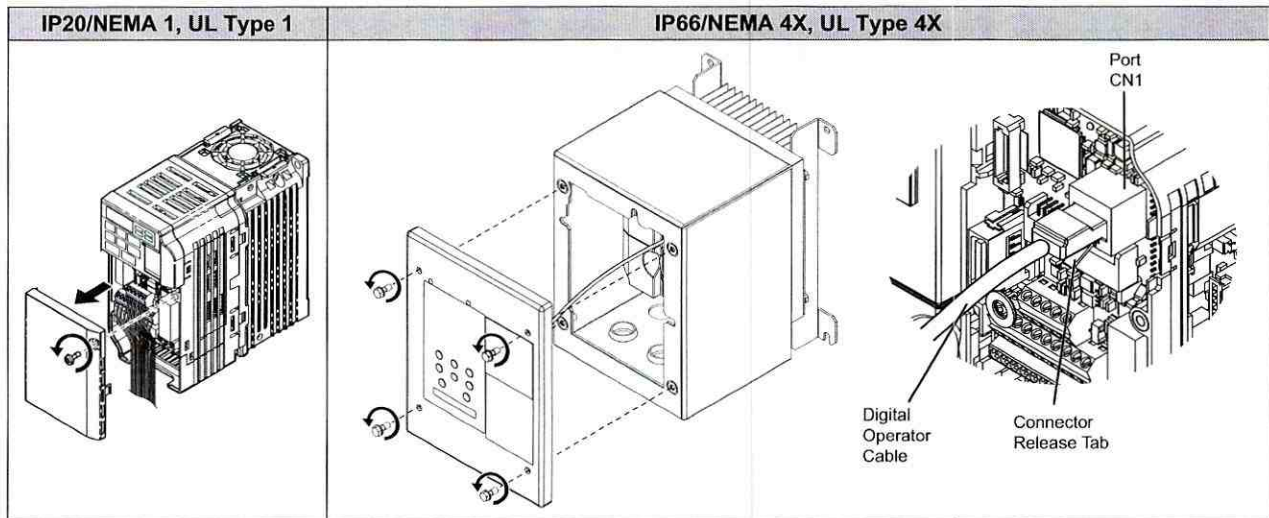

Table 1.3 IP66/NEMA 4X, UL Type 4X Enclosure Front Cover Installation Bolt Size

Voltage Class	Drive Model	Installation Bolt Size
Single-Phase 200 V Class	BV0001G to BV0012G	M5
Three-Phase 200 V Class	2V0001G to 2V0020G	M5
	2V0030G to 2V0069G	M6
Three-Phase 400 V Class	4V0001G to 4V0011G	M5
	4V0018G to 4V0038G	M6

5.8 On **IP20/NEMA 1, UL Type 1** enclosure models, loosen the screw on the front of the bottom cover and remove it from the drive. All models except 2V0006F require removing a plastic lower terminal cover prior to removing the bottom cover.

On **IP66/NEMA 4X, UL Type 4X** enclosure models, remove the lower terminal cover (if provided) from the drive.

The lower terminal cover is not present on certain models.

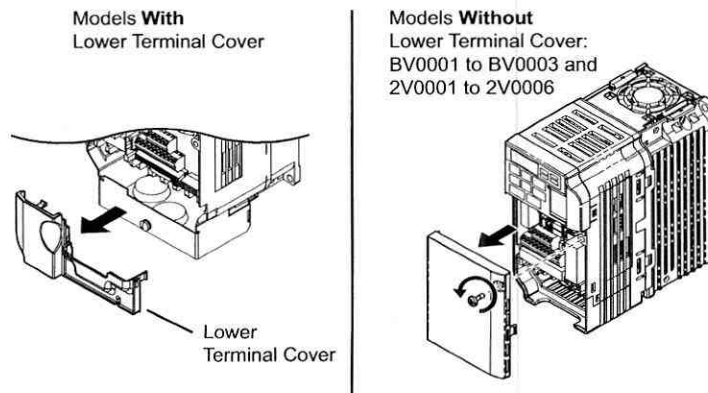

STEP 5 □ Install the 24 V Transducer Power Supply (continued)

Note: The lower terminal cover is required for secure mounting of the 24V Power Supply on the models shown in *Table 1.4*. Contact your Yaskawa representative for ordering if you have a model listed in *Table 1.4* and the lower terminal cover is not present on your drive.

Table 1.4 Lower Terminal Cover Part Number by Model

Drive Model	Terminal Cover Part Number
BV0006□ and BV0010□ 2V0010□ and 2V0012□ 4V0002□ to 4V0009□	CVST31300
BV0012□ 2V0020□ 4V0011□	CVST31301
Other models	Not required

Table 1.5 Remove the Bottom Cover and Lower Terminal Cover

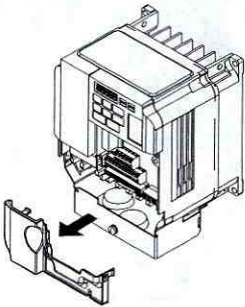
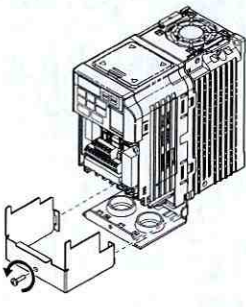
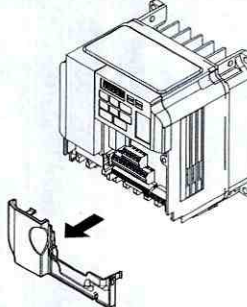
IP20/NEMA 1, UL Type 1	IP66/NEMA 4X, UL Type 4X	
Lower Terminal Cover on All Models Except Models: BV0001 to BV0003 2V0001 to 2V0006	Bottom Cover on All Models	Terminal Cover on Models BV0006G to BV0010G 2V0010G to 2V0020G 4V0002G to 4V0011G
		

5.9 On IP20/NEMA 1, UL Type 1 enclosure models, loosen the screws attaching the NEMA 1, UL Type 1 conduit bracket to the drive to allow the bracket to swing out to provide easier access to the ground screw. Do not remove the screws.

Table 1.6 Loosen Conduit Bracket Screws

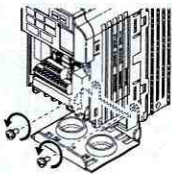
IP20/NEMA 1, UL Type 1	IP66/NEMA 4X, UL Type 4X
	Not applicable.

5.10 Remove the 24V Power Supply cover.

Table 1.7 Remove 24V Power Supply Cover

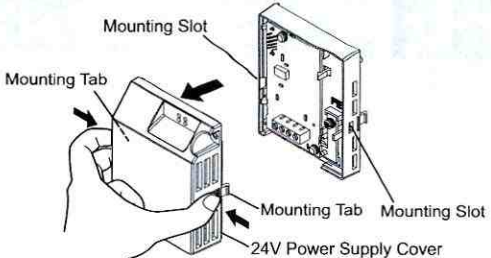
IP20/NEMA 1, UL Type 1 and IP66/NEMA 4X, UL Type 4X

STEP 5

□ Install the 24 V Transducer Power Supply (continued)

5.11 Select one of the four ground wires packaged with the 24V Power Supply unit and attach the ground wire to the drive.

Select the correct ground wire shown in *Figure 1.5* by first removing the drive ground terminal screw as shown in *Table 1.8*. Yaskawa recommends using a long Phillips screwdriver with a magnetic tip to aid in keeping the screw captive during removal and installation.

Test fit the screw (size M3.5 to M6) into each of the four ground wire drive-side ring lugs prior to installation. Ground wire selection varies by drive model.

With the appropriate screw removed, attach the drive-side of the ground wire to the drive ground terminal and tighten all loosened screws.

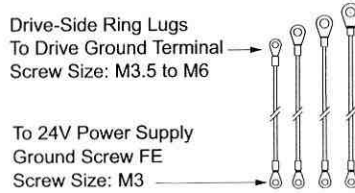

Figure 1.5 Ground Wire Selections

Table 1.8 Drive Ground Terminal and Screw Location

IP20/NEMA 1, UL Type 1		IP66/NEMA 4X, UL Type 4X
Models BV0001 to BV0003 2V0001 to 2V0006	All Other Models	

5.12 Reattach the bottom terminal cover.

Table 1.9 Reattach Bottom Terminal Cover

IP20/NEMA 1, UL Type 1	IP66/NEMA 4X, UL Type 4X
	<p>Not applicable.</p>

STEP 5 □ Install the 24 V Transducer Power Supply (continued)

5.13 Connect the ground wire to the 24V Power Supply at ground terminal FE.

Route the free end of the ground wire to the front of the 24V Power Supply via the through-slot as shown in *Table 1.10* and connect the ground wire. Tighten the screw to 0.5 ~ 0.6 Nm or (4.4 ~ 5.3 in lbs) using an M3 Phillips screwdriver.

Table 1.10 Connect Ground Wire to 24V Power Supply
IP20/NEMA 1, UL Type 1 and IP66/NEMA 4X, UL Type 4X

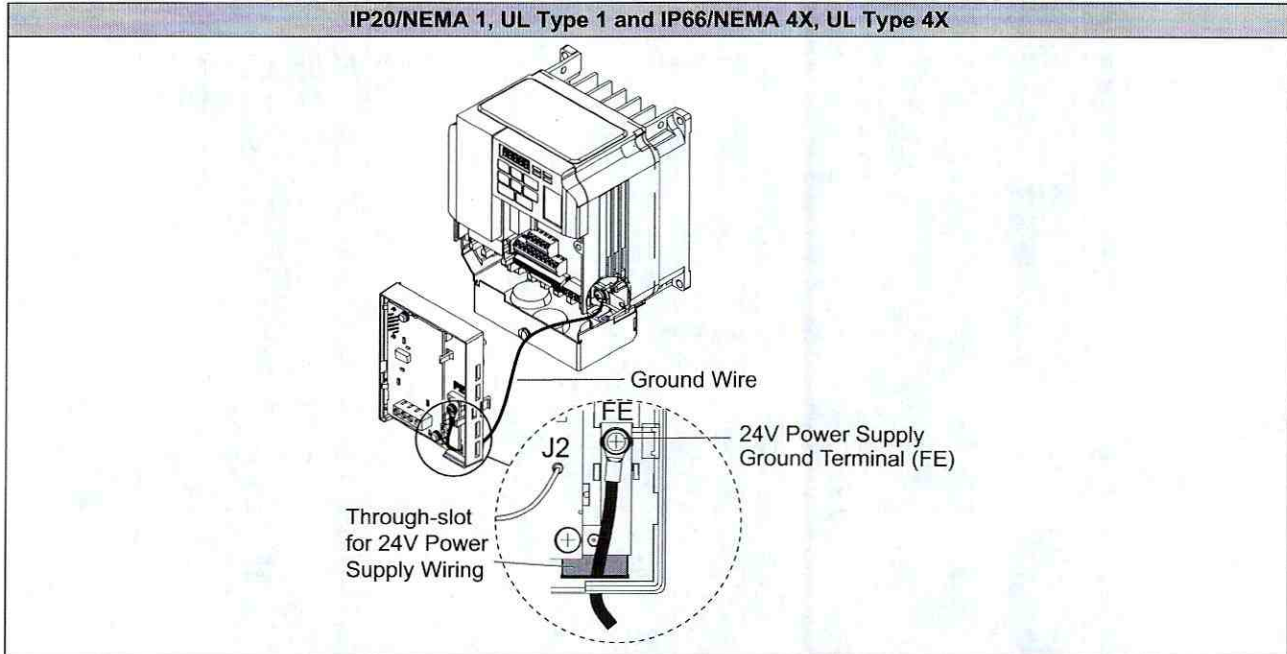

5.14 Connect the white J2 lead wire to terminal A2 on drive terminal block TB1-2.

Route the free end of the J2 wire to the A2 terminal on the drive via the through-slot on the 24V Power supply as shown in *Table 1.11*.

Table 1.11 Connect J2 Lead Wire to Drive
IP20/NEMA 1, UL Type 1 and IP66/NEMA 4X, UL Type 4X

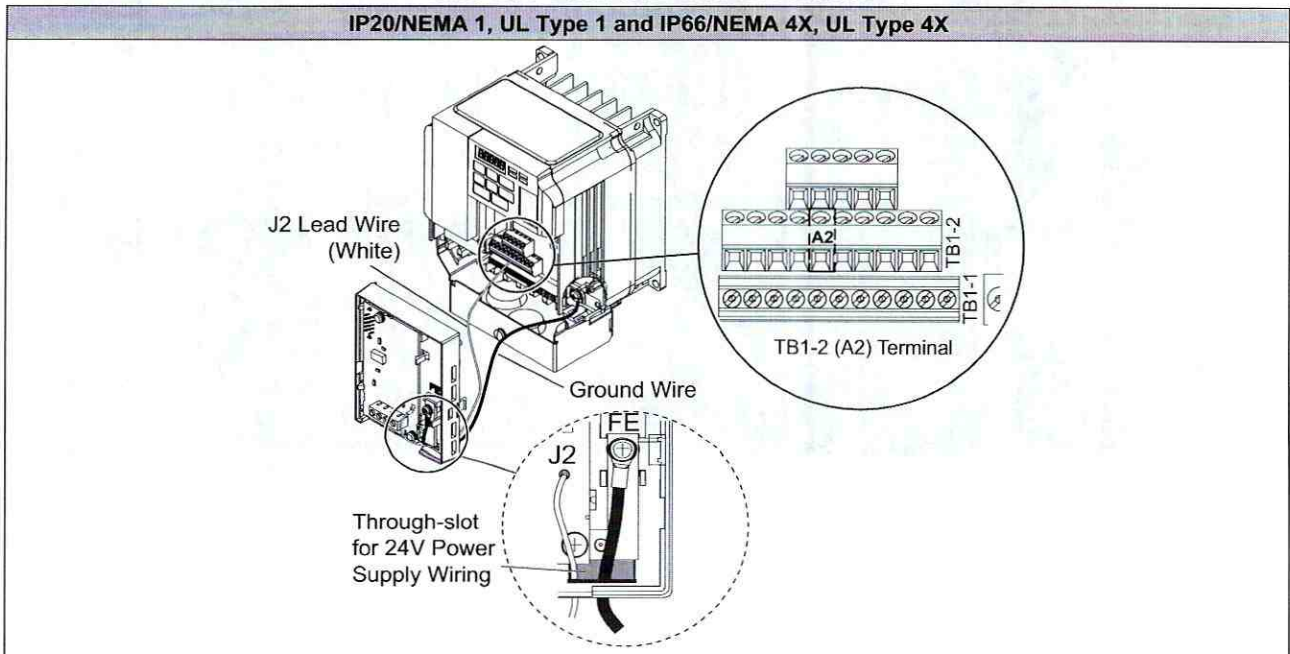

STEP 5

□ Install the 24 V Transducer Power Supply (continued)

5.15 On models BV0006□ to BV0018□, 2V0010□ to 2V0020□, and 4V0002□ to 4V0011□, insert the ground wire and J2 lead wire into the terminal cover wire notch.

Table 1.12 Insert Wires Into Routing Notch

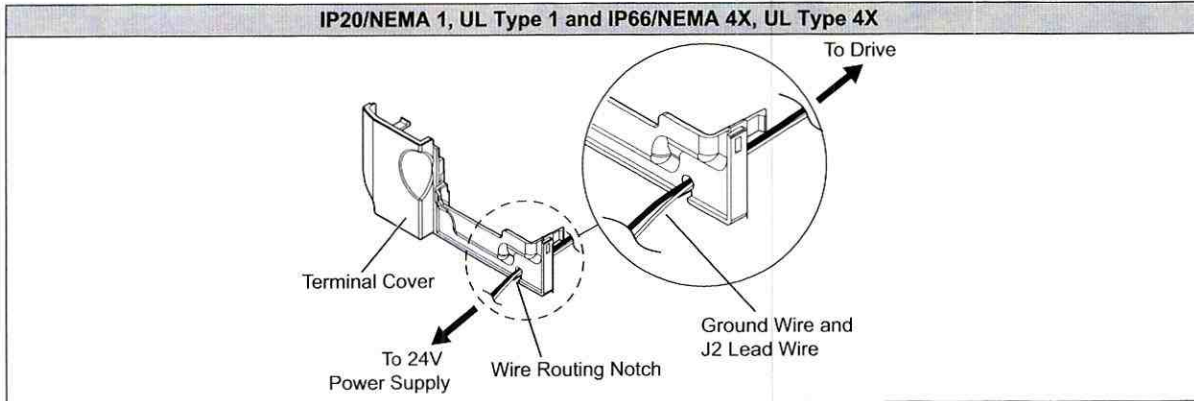

After inserting the ground wire and J2 lead wire into the notch, attach the terminal cover to the 24V Power Supply.

Table 1.13 Connect Terminal Cover to 24V Power Supply

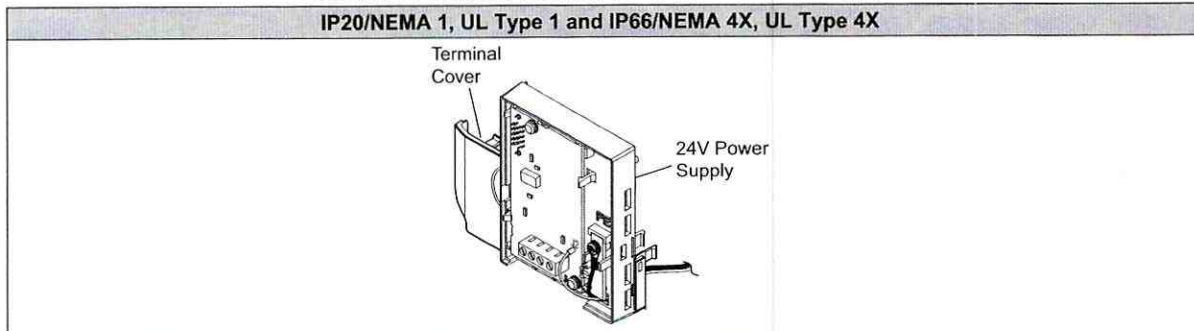

5.16 Attach the 24V Power Supply or 24V Power Supply/Terminal Cover combination to the drive.

Properly seat the tabs on the left and right sides of the 24V Power Supply unit into the drive case mounting slots and snap into place.

NOTICE: *Damage to Equipment.* Take proper precautions when attaching the 24V Power Supply to the drive so that no cables are pinched between the 24V Power Supply and the drive. Failure to comply may result in damage to circuitry and equipment.

Table 1.14 Attach 24V Power Supply to Drive

