





No.	Name	Display	Content
8	FWD/REV	FWD	Indicates forward motor operation.
		REV	Indicates reverse motor operation.
9	Function Key 1 (F1)	<-MONITOR->	Pressing  displays the next Quick Monitor.
		←	Pressing  scrolls the cursor to the left.
		Home	Pressing  returns to the top menu (Frequency Reference).
		ESC	Pressing  returns to the previous display.
		Monitor	Pressing  switches Monitor mode.

- <1> Displayed when in Frequency Reference Mode.
- <2> Displayed when in Frequency Reference Mode and Monitor Mode.

◆ Setting the Real Time Clock

The time and date must be set when a new HOA keypad is plugged in and the drive is powered up. The HOA keypad will display the time and date setup screen for 30 seconds. If a button is not pressed during this time, the display will clear and a “Clock Not Set” alarm will flash. Pressing the F2 (Data) key will display the setting screen again.

■ Feedback Loss Wire Break Alarm

If there is no sensor wired to the drive, a “Feedback Loss – Wire Break” alarm will flash on the display. Providing the proper feedback device signal will clear the Feedback Loss alarm.

The drive requires a feedback device (e.g., pressure transducer, flow meter, etc.) to perform automatic system regulation. Any analog 0~10 V or 4-20 mA feedback device can be used in combination with the drive.

Note: The factory default setting for the drive is 4~20 mA feedback device connected to analog input A2.

■ Real Time Clock Setting Display

Note: Setting the Real-Time Clock will clear a “Clock Not Set” alarm.

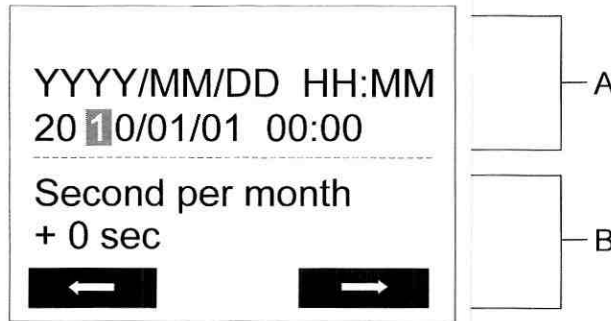

A – Real Time Clock Setting Display Set in 24-Hour Clock Time B – Gain/Loss Adjustment Display

Figure i.27 Real Time Clock Adjustment Display

Display	Description
YYYY	Set the year with the last two digits.
MM	Set the month with two digits.
DD	Set the day with two digits.
HH:MM	Set the hours and minutes, with two digits for each. Note: Set in 24-hour clock time. After initial setup, the time will display in 12-hour clock time.
Second per month	Set the gain or loss in seconds per month. Note: This does not need to be set for the RTC to function properly.

Moving the Cursor

Pressing the F2 key or the RESET key will move the cursor to the digit on the right. Pressing the F1 key will move the cursor to the left.

i.6 Start-Up Programming and Operation

Changing Settings

- **Changing YYYY/MM/DD HH:MM:** Pressing the up arrow key will increase the number selected by the cursor from 0 to 9. Pressing the down arrow key will decrease the number selected by the cursor from 0 to 9.
- **Setting the Seconds per Month:** *This setting does not need to be adjusted.* Pressing the up arrow key will increase the number selected by the cursor from -504 to +488 in increments of 8. Pressing the down arrow key will decrease the number selected by the cursor from -504 to +488 in increments of 8.

The feature is used to keep the RTC in sync with an external device clock, like a PLC or BAS system, and will adjust the clock by a set amount of seconds every month.

Real-Time Clock Setting at Initial Power-up of a New Drive

Setting the Real-time clock is required at power-up of a new HOA operator or after digital operator battery replacement.

Table i.18 illustrates how to set the Real-Time Clock at initial power-up of a new drive.

Table i.18 Clock Adjustment Procedure at Power-up of a New Drive

Procedure		Display
1	Turn the power on. The Real Time Clock Adjustment Display will appear. Use the right arrow key to select the desired digit, then set the correct date and 24-hour clock time using the up and down arrow keys.	
2	After entering the Real-Time Clock data, press the ENTER key to save the changes. The display will indicate "Entry Accepted" and return to the initial display in step 3 and the alarm LED will be OFF.	
3	Initial display.	

Manual Clock Adjustment by Setting o4-17 to 1

The following actions are possible in the Clock Adjustment Mode:

- Set the current time
- Check the time set to the drive Real-Time Clock

Table i.19 illustrates how to set the Real-Time Clock manually.

Table i.19 Manual Clock Adjustment Procedure by Setting o4-17 to 1

Procedure		Display
1	The "Clock Not Set" display will appear if the Real-Time Clock data is not entered within 30 seconds of power-up of a drive with an HOA operator that has not yet been set.	
2	Use the up and down arrow keys to scroll through display menu until the screen shows "Programming".	

Procedure		Display
3	Press the ENTER key to enter select the parameter setting mode.	
4	Use the up and down arrow keys to scroll through display menu until parameter o4-17 appears.	
5	Press the ENTER key until "0" flashes.	
6	Press the up arrow key so that the display changes to "1".	
7	Press the ENTER key and the time setting screen will appear. Use the right arrow key to select the desired digit, then set the correct date and time using the up and down arrow keys.	
8	After entering the correct time, press the ENTER key to save the changes. The display will return to the display shown in step 5 and the alarm LED will be OFF.	

■ o4-17: Real-Time Clock Setting (Resetting RTC to Factory Default)

No. (Addr. Hex)	Name	Description	Values
o4-17 (3100)	Set/Reset Real-time Clock	Sets the current date and time for the Real-Time Clock. 0: — No Setting 1: Real-Time Clock Set 2: Real-Time Clock Reset	Default: 0 Range: 0 to 2

Setting 0: — —

No Setting (Default)

Setting 1: Set

The digital operator will show the Clock Adjustment display. In Clock Adjustment Mode the user can adjust the Real-Time Clock.

Setting 2: Reset

The Real-Time Clock data is cleared. A Clock Not Set alarm will occur until o4-17 is set to 1 and the Real-Time Clock is set.

◆ Menu Structure for HOA Keypad

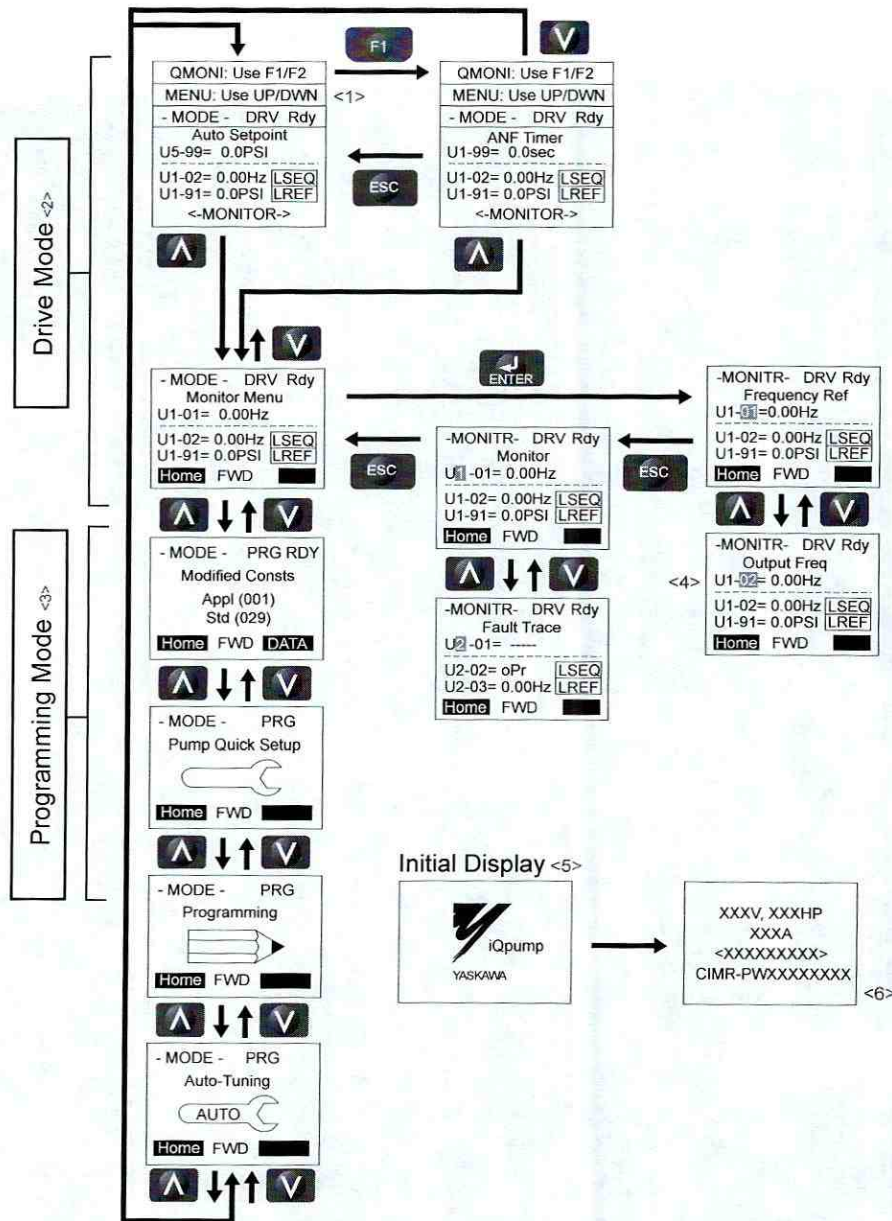

Figure i.28 HOA Keypad Menu and Screen Structure

- <1> The display cycles between these three displays on the initial startup screen and the Quick Monitor screens.
- <2> Pressing "AUTO" or "HAND" will start the motor.
- <3> Drive cannot operate motor.
- <4> Flashing characters are shown with white letters on gray background. (Example: [E])
- <5> The Frequency Reference appears after the initial display that shows the product name.
- <6> The information that appears on the display will vary depending on the drive model.

◆ Detailed Parameter Descriptions

■ A1-03: Initialize Parameters

Resets parameters to default values or performs an Application Preset for fan or pump applications. After initialization, the setting for A1-03 automatically returns to 0.

No.	Parameter Name	Setting Range	Default
A1-03	Initialize Parameters	0, 1110, 2220, 3330, 5550, 6008, 6009, 7770, 7771	0

Setting 1110: User Initialize

Resets parameters to the values selected by the user as User Settings. User Settings are stored when parameter o2-03 is set to "1: Set defaults".

Note: User Initialization resets all parameters to a user-defined set of default values previously saved to the drive. Set parameter o2-03 to 2 to clear the user-defined default values.

Setting 2220: 2-Wire Initialization

Resets parameters to default settings with digital inputs S1 and S2 configured as Forward run and Reverse run, respectively.

Setting 3330: 3-Wire Initialization

Resets parameters to default settings with digital inputs S1, S2, and S5 configured as Run, Stop, and Forward/Reverse respectively.

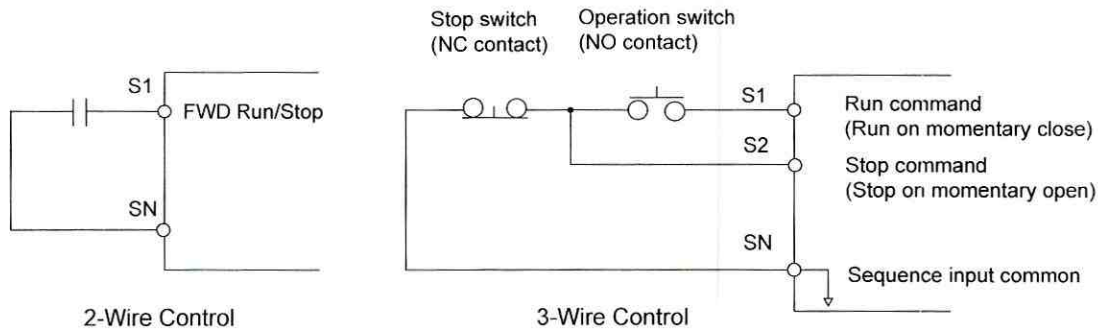

Figure i.29 2-Wire and 3-Wire Control Wiring Examples

Notes on Parameter Initialization

The parameters shown in *Table i.20* will not be reset when the drive is initialized by setting A1-03 = 2220 or 3330.

Table i.20 Parameters Not Changed by Drive Initialization

No.	Parameter Name
A1-00	Language Selection
E1-03	V/f Pattern Selection
F6-08	Communication Parameter Reset
L8-35	Installation Selection
o2-04	Drive/kVA Selection

Setting 5550: Terminal/Control Initialize

An oPE04 error appears on the digital operator when a terminal block with settings saved to its built-in memory is installed in a drive that has edited parameters. Set A1-03 to 5550 to use the parameter settings saved to the terminal block memory.

Application Presets are available to facilitate drive setup for commonly used applications. Selecting one of these Application Presets automatically assigns functions to the input and output terminals and sets a predefined group of parameters to values appropriate for the selected application.

In addition, the parameters most likely to be changed are assigned to the group of User Parameters, A2-01 through A2-16. User Parameters are part of the Setup Group, which provides quicker access by eliminating the need to scroll through multiple menus.

i.6 Start-Up Programming and Operation

Setting 6008: Pressure Control

Application Preset for Pressure Control applications.

Setting 6009: Pump Down Level

Application Preset for Pump Down Level applications.

Setting 7770: General Purpose

General Purpose Application Preset.

Setting 7771: Submersible Motor General Purpose Operation

General Purpose Application Preset.

■ b1-01: Frequency Reference Selection 1

Selects the frequency reference source 1 for the AUTO mode.

Note: If a Run command is input to the drive but the frequency reference entered is 0 or below the minimum frequency, the RUN indicator LED on the digital operator will light and the STOP indicator will flash.

No.	Parameter Name	Setting Range	Default
b1-01	Frequency Reference Selection 1	0 to 4	0

In order to run the drive and motor, the drive must receive a Run command and an Auto Setpoint command. Parameter b1-01 specifies the origin of the Auto setpoint when in AUTO Mode. Switch to AUTO mode by pressing the AUTO button on the HOA keypad while the drive is stopped.

Note: If a Run command is input to the drive without a corresponding Auto setpoint, the Run indicator on the HOA keypad will turn on and the STOP indicator on the keypad will blink.

If the drive should follow the "HAND Reference" set by the HOA keypad, use HAND Mode by pressing the HAND key and set P5-01 to "1: Hand Reference (P5-02)." The HAND reference can then be entered into the U1-01 monitor parameter in the "-DRIVE-" Menu.

The drive offers the ability to provide four types of "Auto Setpoint" reference sources. These Auto Setpoint reference sources are determined by the setting of b1-01 and the drive set to AUTO Mode by pressing the AUTO key on the keypad.

Prior to programming, it is recommended to select the system units (P1-02) and the feedback device, Scaling (P1- 03) first. P1-03 will automatically scale the drive setpoint.

Example: P1-02 = 1: PSI

P1-03 = 200, feedback range = 200 PSI.

If the drive should follow an "Auto Set-Point" set by the HOA keypad: Set b1-01 to "0: Operator" (factory default). The Auto setpoint can then be entered into the U5-99 monitor parameter in the "-DRIVE-" menu.

Setting 0: Operator (HOA keypad)

Using this setting, the frequency reference can be input by:

- switching between the multi-speed references in the d1-□□ parameters.
- entering the frequency reference on the operator keypad.

This selection will also switch PID setpoint to Q1-01.

Setting 1: Terminals (Analog Input Terminals)

Using this setting, an analog frequency reference can be entered from:

- Terminal A1 using a 0 to 10 Vdc signal.
- Terminal A2 using either a 0 to 10 Vdc or a 0/4 to 20 mA signal.

Note: Terminal A2 supports voltage and current input. The input signal type must be set up by setting DIP switch S1 and adjusting parameter H3-09.

Entering only the main frequency reference:

Using Control Circuit Terminal A1 (0 to 10 Vdc voltage input):

Use a circuit such as the one shown in *Figure i.30* or an external 0 to 10 Vdc voltage source like a PLC analog output and set the input level selection for A1 in parameter H3-02 as desired.

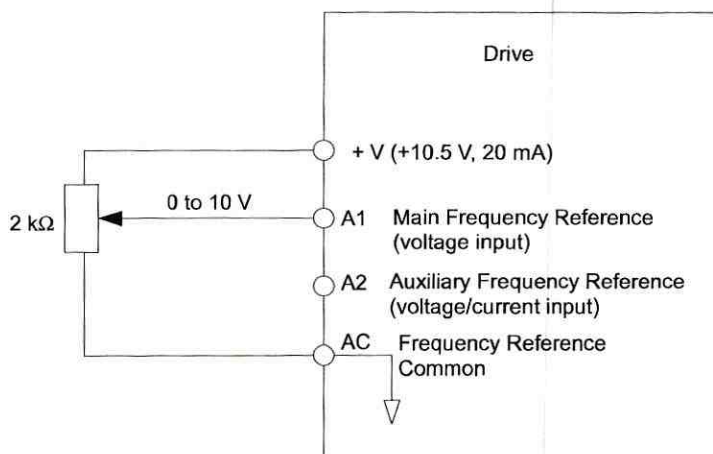

Figure i.30 Setting the Frequency Reference by Voltage Input

- Using Control Circuit Terminal A2 (0 to 10 Vdc voltage input)

Use the same connection as explained for terminal A1 for terminal A2. Make sure that switch S1 is set to “V” and set the appropriate signal level for terminal A2 by entering 0 or 1 into parameter H3-09. The terminal A2 function must be set to frequency bias by entering 0 into parameter H3-10.

- Using Control Circuit Terminal A2 (0/4 to 20 mA current input)

Connect input A2 to an external current source such as the one shown in *Figure i.31*. Make sure that switch S1 is set to “I” and set the appropriate signal level for terminal A2 by entering 2 (4 to 20 mA) or 3 (0 to 20 mA) into parameter H3-09. The terminal A2 function must be set to frequency bias by entering 0 into parameter H3-10.

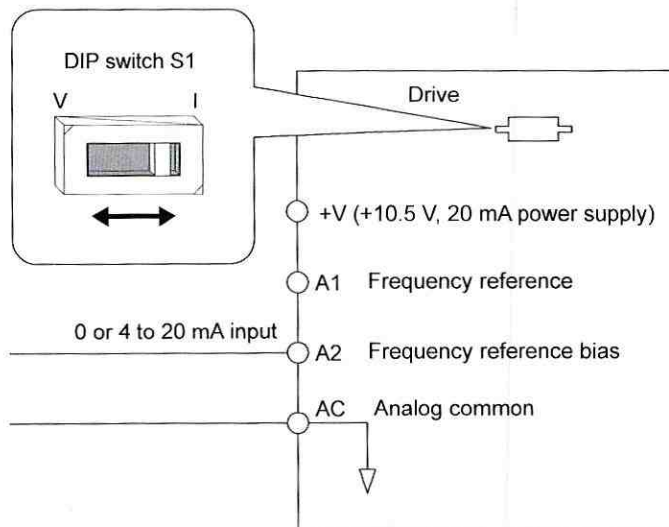

Figure i.31 Setting the Frequency Reference by Current Input

Switching between Main/Auxiliary Frequency References

The frequency reference input can be switched between terminal A1 (main) and terminal A2 (auxiliary). When using this function:

- Make sure that b1-01 is set to “1” (Frequency reference from analog input).
- Set the terminal A2 function to auxiliary frequency (H3-10 = 2).
- Set one digital input to multi-speed 1 (H1-□□ = 3, default for S5).

The frequency reference value is read from

- Terminal A1 when the digital input set for multi-speed 1 is open.
- Terminal A2 when the digital input set for multi-speed 1 is closed.

Figure i.31 shows a wiring example for main/auxiliary reference switching using digital input S5.

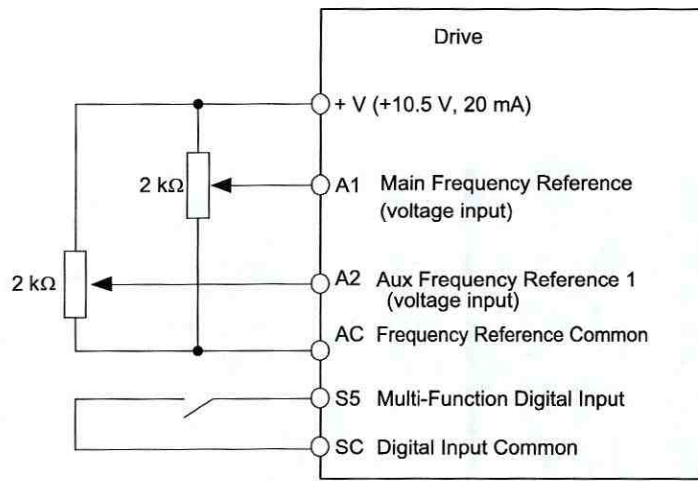

Figure i.32 Switching between Analog Reference 1 and 2

Setting 2: MEMOBUS/Modbus Communications

This setting requires entering the frequency reference via the RS-485/422 serial communications port (control terminals R+, R-, S+, S-).

To setup the drive to receive the “Auto Setpoint” from serial communication, set b1-01 to “2: Serial Com,” and connect the RS-422/RS-485 serial communications cable to terminals R+, R-, S+, and S- on the control I/O terminal block. Refer to 78 to see the connection diagram using a PC to provide the auto setpoint reference to the drive.

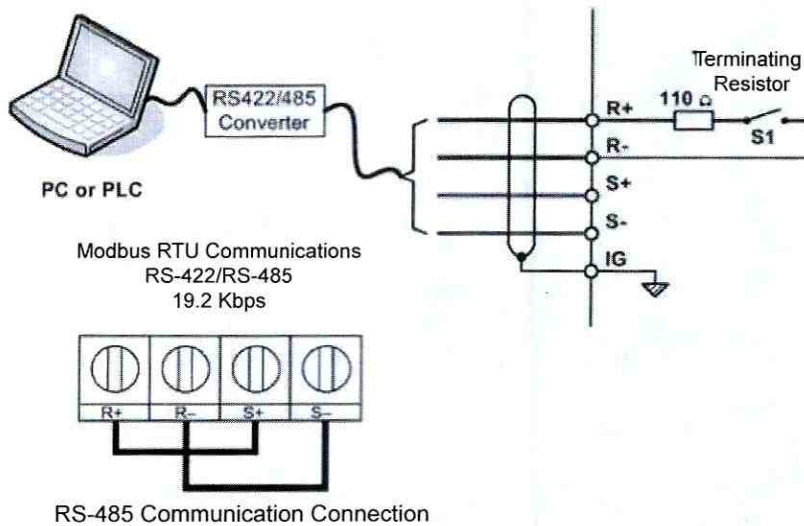

Figure i.33 PC or PLC Connection Diagram

Setting 3: Option card

This setting requires entering the frequency reference via an option board plugged into connector CN5 on the drive control board. Consult the option board manual for instructions on integrating the drive with the communication system.

Note: If the frequency reference source is set for Option PCB (b1-01 = 3), but an option board is not installed, an oPE05 Operator Programming Error will be displayed on the digital operator and the drive will not run.

To setup the drive to receive the “Auto Setpoint” for a network communication option card, set b1-01 to “3: Option PCB”, and plug a supported communication option card into the drive control PCB. Consult the manual supplied with the option for instructions on integrating the drive into the network system.

Setting 4: Pulse Train Input

This setting requires a pulse train signal to terminal RP to provide the frequency reference. Follow the directions below to verify that the pulse signal is working properly.

Pulse Train Input Specifications	
Response Frequency	0.5 to 32 kHz
Duty Cycle	30 to 70%
High Level Voltage	3.5 to 13.2 V
Low Level Voltage	0.0 to 0.8 V
Input Impedance	3 kΩ

Verifying the Pulse Train is Working Properly

- Set b1-01 to 4 and set H6-01 to 0.
- Set the H6-02 to the pulse train frequency value that equals 100% of the frequency reference.
- Enter a pulse train signal to terminal RP and check for the correct frequency reference on the display.

■ b1-02: Run Command Selection 1

Determines the Run command source 1 in AUTO Mode.

The drive comes factory programmed for Start and Stop from the keypad, but the user can program the drive to receive a Run command from four different inputs: digital operator, terminals, serial communications, or an option PCB.

WARNING! *Sudden Movement Hazard. Clear personnel, secure equipment, and check sequence and safety circuitry before starting the drive. Failure to comply could result in death or serious injury from moving equipment.*

To set the drive to receive the Run command from the HOA keypad, set b1-02 to “0: Operator,” and the HAND key will be used to provide the Run command to the drive.

To set the drive to receive the Run command from the external terminals, set b1-02 to “1: Terminals” and initiate an external Run command by a contact closure between terminals S1 and SN.

Note: Using the external terminals requires setting the drive to AUTO Mode by pressing the AUTO key.

No.	Parameter Name	Setting Range	Default
b1-02	Run Command Selection 1	0 to 3	0

Setting 0: Operator (HOA keypad)

This setting requires entering the Run command via the HOA keypad AUTO key and also illuminates the HAND indicator on the digital operator.

Setting 1: Control Circuit Terminal

This setting requires entering the Run command via the digital input terminals using one of following sequences:

- 2-Wire sequence 1:
Two inputs (FWD/Stop-REV/Stop). Set A1-03 to 2220 to initialize the drive and preset terminals S1 and S2 to these functions. This is the default setting of the drive.
- 2-Wire sequence 2:
Two inputs (Start/Stop-FWD/REV).
- 3-Wire sequence:
Three inputs (Start-Stop-FWD/REV). Set A1-03 to 3330 to initialize the drive and preset terminals S1, S2, and S5 to these functions.

Setting 2: MEMOBUS/Modbus Communications

This setting requires entering the Run command via serial communications by connecting the RS-485/422 serial communication cable to control terminals R+, R-, S+, and S- on the removable terminal block.

Setting 3: Option Card

This setting requires entering the Run command via the communication option board by plugging a communication option board into the CN5 port on the control PCB. Refer to the option board manual for instructions on integrating the drive into the communication system.

Note: If b1-02 is set to 3, but an option board is not installed in CN5, an oPE05 operator programming error will be displayed on the digital operator and the drive will not run.

■ b1-03: Stopping Method Selection

Selects how the drive stops the motor when the Run command is removed or when a Stop command is entered.

Note: Parameter b1-11, Run Delay at Stop (Back Spin Timer), is effective for all stopping methods (b1-03 = 0 to 3), not only Coast to Stop w/ Timer (b1-03 =3).

i.6 Start-Up Programming and Operation

No.	Parameter Name	Setting Range	Default
b1-03	Stopping Method Selection	0 to 3	1

Setting 0: Ramp to Stop

When the Run command is removed, the drive will decelerate the motor to stop. The deceleration rate is determined by the active deceleration time. The default deceleration time is set to parameter C1-02.

When the output frequency falls below the level set in parameter b2-01, the drive will start DC injection, Zero Speed Control, or Short Circuit Braking.

Setting 1: Coast to Stop

When the Run command is removed, the drive will shut off its output and the motor will coast (uncontrolled deceleration) to stop. The stopping time is determined by the inertia and the friction in the driven system.

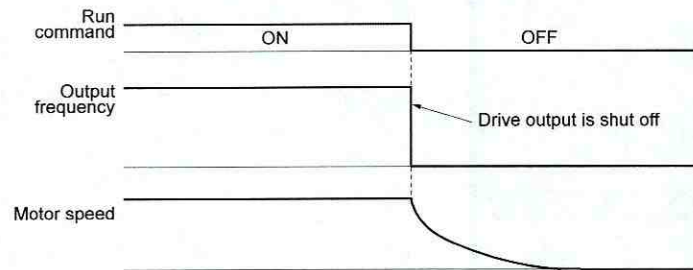

Figure i.34 Coast to Stop

Note: After a stop is initiated, any subsequent Run command entered will be ignored until the minimum baseblock time (L2-03) has expired. Do not enter Run command until it has come to a complete stop. Use DC Injection at Start or Speed Search to restart the motor before it has completely stopped.

Setting 2: DC Injection Braking to Stop

When the Run command is removed, the drive will enter baseblock (turn off its output) for the minimum baseblock time (L2-03). When the minimum baseblock time has expired, the drive will inject the amount DC Injection Braking is set in parameter b2-02 into the motor windings to brake the motor. The stopping time in DC Injection Braking to Stop is significantly faster compared to Coast to Stop.

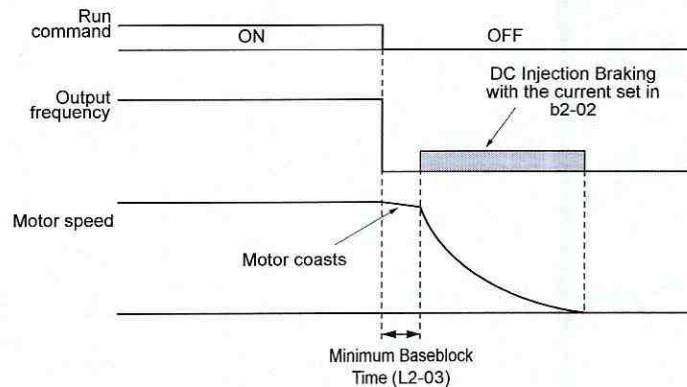

Figure i.35 DC Injection Braking to Stop

DC Injection Braking time is determined by the value set to b2-04 and the output frequency at the time the Run command is removed. It can be calculated by:

$$\text{DC Injection brake time} = \frac{(b2-04) \times 10 \times \text{Output frequency}}{\text{Max. output frequency (E1-04)}}$$

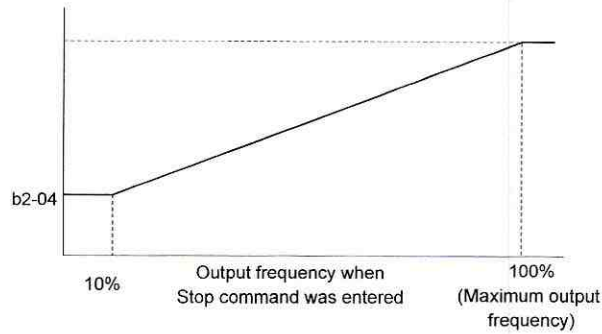

Figure i.36 DC Injection Braking Time Depending on Output Frequency

Note: If an overcurrent (oC) fault occurs during DC Injection Braking to Stop, lengthen the minimum baseblock time (L2-03) until the fault no longer occurs.

Setting 3: Coast to Stop with Timer (Used for Back Spin Control on Vertical Turbine Pumps)

When the Run command is removed, the drive coasts to a stop. If parameter b1-11 = 0, the coast-timer (Run Delay at Stop) becomes a value determined by a combination of output frequency and C1-02. However, if b1-11 > 0, the Run Delay at Stop timer is set to b1-11. If the Run command is reissued during the Run Delay at Stop timer time, the drive WILL restart when the timer expires without the need to re-cycle the Run command. The Run Delay at Stop timer will operate for both AUTO Mode and HAND Mode. The Run Delay at Stop timer will still operate when the drive goes to sleep and then wakes up. During the Run Delay at Stop timer execution, the HOA keypad will display a Start Delay message.

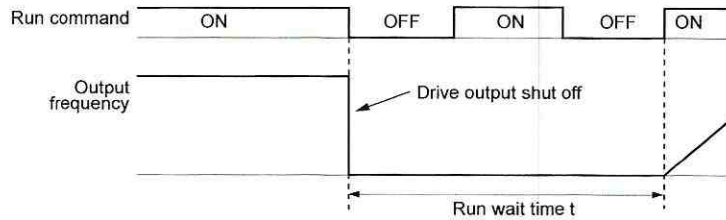

Figure i.37 Coast to Stop with Timer

The wait time t is determined by the output frequency when the Run command is removed and by the active deceleration time.

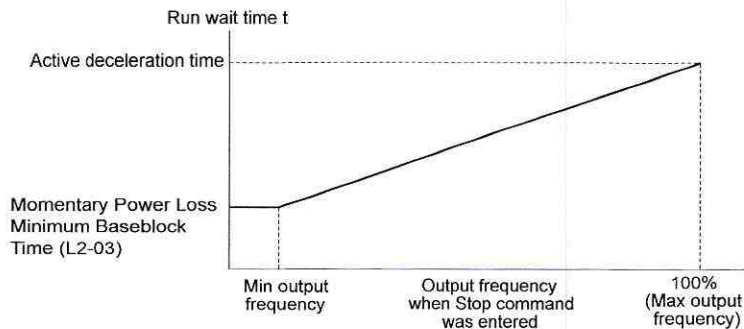

Figure i.38 Run Wait Time Depending on Output Frequency

■ **b3-01: Speed Search Selection at Start**

Determines if Speed Search is automatically performed when a Run command is issued.

No.	Parameter Name	Setting Range	Default
b3-01	Speed Search Selection at Start	0, 1	0

Setting 0: Disabled

This setting starts operating the drive at the minimum output frequency when the Run command is entered. If external Speed Search 1 or 2 is already enabled by a digital input, the drive will start operating with Speed Search.

i.6 Start-Up Programming and Operation

Setting 1: Enabled

This setting performs Speed Search when the Run command is entered. The drive begins running the motor after Speed Search is complete.

■ b5-01: PID Function Setting

Enables and disables the PID operation and selects the PID operation mode.

No.	Parameter Name	Setting Range	Default
b5-01	PID Function Setting	0, 1	1

Setting 0: PID disabled

Setting 1: Output frequency = PID output 1

The PID controller is enabled and the PID output builds the frequency reference. The PID input is D controlled.

■ C1-01 to C1-04: Accel, Decel Times 1 and 2

Two different sets of acceleration and deceleration times can be set in the drive by digital inputs, motor selection, or switched automatically.

Acceleration time parameters always set the time to accelerate from 0 Hz to the maximum output frequency (E1-04). Deceleration time parameters always set the time to decelerate from maximum output frequency to 0 Hz. C1-01 and C1-02 are the default active accel/decel settings.

No.	Parameter Name	Setting Range	Default
C1-01	Acceleration Time 1	0.0 to 6000.0 s ^{<1>}	20.0 s
C1-02	Deceleration Time 1		10.0 s
C1-03	Acceleration Time 2		
C1-04	Deceleration Time 2		

<1> The setting range for the acceleration and deceleration times is determined by the accel/decel time setting units in C1-10. For example, if the time is set in units of 0.01 s (C1-10 = 0), the setting range becomes 0.00 to 600.00 s.

Switching Acceleration Times by Digital Input

Accel/decel time 1 is active by default if no input is set. Activate accel/decel times 2, 3, and 4 by digital inputs (H1-□□ = 7 and 1A) as explained in *Table i.21*.

Table i.21 Accel/Decel Time Selection by Digital Input

Accel/Decel Time Sel. 1 H1-□□ = 7	Accel/Decel Time Sel. 2 H1-□□ = 1A	Active Times	
		Acceleration	Deceleration
0	0	C1-01	C1-02
1	0	C1-03	C1-04

Figure i.39 shows an operation example for changing accel/decel times. The example below requires that the stopping method be set for “Ramp to stop” (b1-03 = 0).

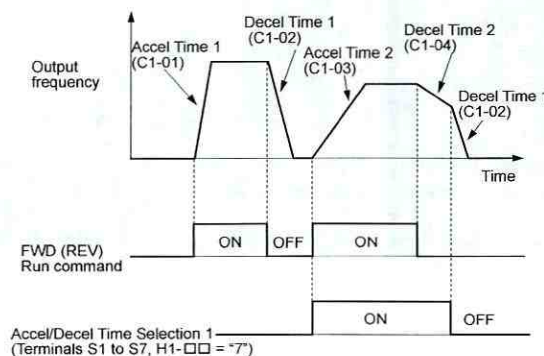

Figure i.39 Timing Diagram of Accel/Decel Time Change

■ **E2-01: Motor Rated Current**

Provides motor control, protects the motor, and calculates torque limits. Set E2-01 to the full load amps (FLA) stamped on the motor nameplate. If Auto-Tuning completes successfully, the value entered to T1-04 will automatically be saved to E2-01.

No.	Parameter Name	Setting Range	Default
E2-01	Motor Rated Current	10% to 200% of the drive rated current </>	Determined by o2-04

<1> Display is in the following units:
 BV0006 to BV0018, 2V0006 to 2V0040, and 4V0002 to 4V0023: 0.01 A units.
 2V0056 to 2V0069 and 4V0031 to 4V0038: 0.1 A units.

Note: An oPE02 error will occur if the motor rated current in E2-01 is set lower than the motor no-load current in E2-03. Set E2-03 correctly to prevent this error.

■ **H1-01 to H1-07: Functions for Terminals S1 to S7**

These parameters assign functions to the multi-function digital inputs.

No.	Parameter Name	Setting Range	Default
H1-01	Multi-Function Digital Input Terminal S1 Function Selection	2 to B0	40 (F) </> : Forward Run Command (2-Wire sequence)
H1-02	Multi-Function Digital Input Terminal S2 Function Selection	2 to B0	F: Through Mode
H1-03	Multi-Function Digital Input Terminal S3 Function Selection	0 to B0	26: External Pump Fault
H1-04	Multi-Function Digital Input Terminal S4 Function Selection	0 to B0	14: Fault Reset
H1-05	Multi-Function Digital Input Terminal S5 Function Selection	0 to B0	8D (0) </> : Multi Setpoint 1
H1-06	Multi-Function Digital Input Terminal S6 Function Selection	0 to B0	80 (3) </> : HAND Mode
H1-07	Multi-Function Digital Input Terminal S7 Function Selection	0 to B0	81 (4) </> : HAND Mode 2

<1> Number appearing in parenthesis is the default value after performing a 3-Wire initialization (A1-03 = 3330).

Setting F: Not Used/Through Mode

Select this setting when using the terminal in a pass-through mode. When set to F, an input does not trigger any function in the drive. Setting F, however, still allows the input status of the terminal (open or closed) to be read out by a PLC via a communication option or MEMOBUS/Modbus communications. The drive input terminals can then be used as remote I/O by the PLC.

Setting 14: Fault Reset

When the drive detects a fault condition, the fault output contact closes, the drive output shuts off, and the motor coasts to stop (specific stopping methods can be selected for some faults such as L1-04 for motor overheat). After removing the Run command, clear the fault either by pressing the RESET key on the digital operator or closing a digital input configured as a Fault Reset (H1-□□ = 14).

Note: Remove the Run command prior to resetting a fault. Fault Reset commands are ignored while the Run command is present.

Setting 20 to 2F: External Fault

The External fault command stops the drive when problems occur with external devices.

To use the External fault command, set one of the multi-function digital inputs to a value between 20 and 2F. The digital operator will display EF□ where □ is the number of the terminal to which the external fault signal is assigned.

For example, if an external fault signal is input to terminal S3, “EF3” will be displayed.

Select the value to be set in H1-□□ from a combination of any of the following three conditions:

- Signal input level from peripheral devices (N.O., N.C.)
- External fault detection method
- Operation after external fault detection

An “On-Delay” timer will be applied to the external fault if it is “Normally Open” and an “Off-Delay” timer will be applied to the external fault if it is “Normally Closed”.

If the external fault is set to “During Run”, the time delay will start after the Run command is received.

Table i.22 shows the relationship between the conditions and the value set to H1-□□:

Terminal statuses, detection conditions, and stopping methods marked with an “O” are applicable to the corresponding settings.

i.6 Start-Up Programming and Operation

Table i.22 Stopping Method for External Fault

Setting	Terminal Status <1>		Detection Conditions <2>		Stopping Method			
	N.O.	N.C.	Always Detected	Detected during Run only	Ramp to Stop (fault)	Coast to Stop (fault)	Fast Stop (fault)	Alarm Only (continue running)
20	O		O		O			
21		O	O		O			
22	O			O	O			
23		O		O	O			
24	O		O			O		
25		O	O			O		
26	O			O		O		
27		O		O		O		
28	O		O				O	
29		O	O				O	
2A	O			O			O	
2B		O		O			O	
2C	O		O					O
2D		O	O					O
2E	O			O				O
2F		O		O				O

<1> Determine the terminal status for each fault, i.e., whether the terminal is normally open or normally closed.

<2> Determine whether detection for each fault should be enabled only during run or always detected.

Settings 40, 41: Forward Run, Reverse Run Command for 2-Wire Sequence

Configures the drive for a 2-Wire sequence.

When an input terminal set to 40 closes, the drive operates in the forward direction. When an input set for 41 closes, the drive operates in reverse. Closing both inputs simultaneously will result in an external fault.

- Note:**
1. This function cannot be used simultaneously with settings 42 and 43.
 2. The same functions are assigned to terminals S1 and S2 when the drive is initialized for 2-Wire sequence.

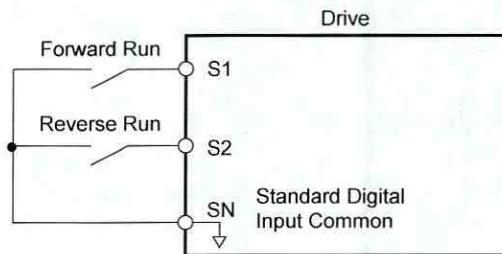

Figure i.40 Example Wiring Diagram for 2-Wire Sequence

Setting 80: HAND Mode

Closing this input will put the drive in HAND Mode.

If this contact is closed within one second of power-up, the drive will honor the utility delay time.

Note: When inputs 80 and 81 are closed simultaneously, input 80 has priority and P5-01 determines the frequency reference.

Setting 81: HAND Mode 2

Closing this input will put the drive in HAND Mode using P5-05 as a frequency reference.

If this contact is closed within one second of power-up, the drive will honor the utility delay time.

Note: When inputs 80 and 81 are closed simultaneously, input 80 has priority and P5-01 determines the frequency reference.

Settings 8D and 8E: Multi Setpoints 1 and 2

Settings 8D and 8E will override all other PID setpoints when closed.

Table i.23 Multi Setpoints 1 and 2

Multi Setpoint 1 (H1-0□ = 8D)	Multi Setpoint 2 (H1-0□ = 8E)	Setpoint Source
Open	Open	Frequency Ref (dependent on b1-01), Set-Point 1 - Q1-01 (when b1-01 = 0), Analog Setpoint (H3-0□ = C), Pulse Input Setpoint (H6-01 = 2), or Memobus setpoint.
Closed	Open	Set Point 2 – Q1-02
Open	Closed	Set Point 3 – Q1-03
Closed	Closed	Set Point 4 – Q1-04

■ H2-01 to H2-03: Terminal MA/MB/MC, P1/PC, and P2/PC Function Selection

The drive has three multi-function output terminals.

No.	Parameter Name	Setting Range	Default
H2-01	Terminal MA, MB and MC Function Selection (relay)	0 to 1AA	E: Fault
H2-02	Terminal P1 Function Selection (open-collector)	0 to 1AA	37: During Frequency Output
H2-03	Terminal P2 Function Selection (open-collector)	0 to 1AA	E: Fault

Setting E: Fault

The output closes when the drive faults (excluding CPF00 and CPF01 faults).

Setting 37: During Frequency Output

The output closes when the drive is outputting a frequency.

Status	Description
Open	Drive is stopped or one of the following functions is being performed: baseblock, DC Injection Braking, Short Circuit Braking.
Closed	Drive is outputting frequency.

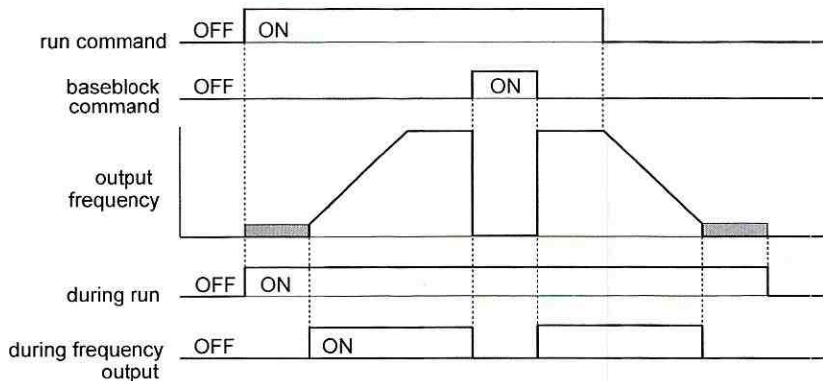

Figure i.41 During Frequency Output Time Chart

■ P1-01: Pump Mode

Selects the base operation mode of the drive controller.

No.	Parameter Name	Setting Range	Default
P1-01	Pump Mode	0, 3	0

Setting 0: Drive only

Designed for single pump stand-alone applications

Setting 3: MEMOBUS network

Up to eight drives can be networked together to provide for system redundancy and precise control.

Staging is disabled when and the drive PID output is influenced by the Water Level / Suction Pressure Control.

The functions listed below will behave slightly different when P1-01 is set to 3:

- **Start Level:** Active on the first pump in the network. Drives in the process of alternation will not undergo this process.
- **Sleep:** Active when the drive is the only drive running on the network.

i.6 Start-Up Programming and Operation

- **Over-cycle Protection:** Active when the drive is the only drive running on the network.
- **Pre-charge:** Active only on the first drive to run in the network.
- **Low City Pressure:** Active on any drive in the network. An alarm condition will cause other drives in the network to stop running and show a “Net Pump Err” message.
- **Utility Delay:** When this function is active, the drive is unavailable to the iQpump MEMOBUS Network and will force the Home Screen text to show “Pump Off Network”.
- **Remote Drive Disable:** When this function is active, the drive is unavailable to the iQpump MEMOBUS Network and will force the Home Screen text to show “Pump Off Network”.

■ P1-02: System Units

Selects the base unit in which most drive PID setpoints, scaling, monitors, limits, and faults/alarm levels will be set.

Note: Set this parameter prior to changing other parameters, as internal scaling is based on P1-02.

No.	Parameter Name	Setting Range	Default
P1-02	System Units	0 to 10	1

Setting 0: No unit

Setting 1: PSI: Pounds per square inch

Setting 2: Pa: Pascals

Setting 3: Bar: Bar

Setting 4: "WC: Inch of water

Setting 5: "Hg: Inch of Mercury

Setting 6: ft: feet

Setting 7: m: meters

Setting 8: °F: Degrees Fahrenheit

Setting 9: °C: Degrees Celsius

Setting 10: Percent

■ P1-03: Feedback Device Scaling

Sets the feedback device scaling used for the PID controller. This information can be found on the nameplate or specification sheet and is usually expressed as the maximum output of the device.

For example, a pressure sensor scaling might be 145.0 PSI at 20 mA output and would require setting P1-03 to 145.0 PSI.

Note: Set this parameter prior to changing other parameters related to the PID feedback, as internal scaling is based on P1-03.

No.	Parameter Name	Setting Range	Default
P1-03	Feedback Device Scaling	0.1 to 6000.0	145.0 PSI

■ P1-04: Start / Draw Down Level

Sets the wake up level from the Sleep function. This setting is dependent on whether PID is normal or inverse acting (b5-09). When the drive is asleep and the PID feedback signal rises above (normal acting) or falls below (inverse acting) this setting for the time set in P1-05, Start Level Delay Time, the drive will wake up.

No.	Parameter Name	Setting Range	Default
P1-04	Start / Draw Down Level	<I>	0.0 PSI

<I> Range is 0.0 to 999.9 with sign-bit “-” or “+” indicating Delta to Setpoint.
Range is -999.9 to 999.9 in drive software versions PRG: 8551 and earlier.

■ Q1-01: PID Controller Setpoint 1

Sets the PID setpoint for the controller. The drive will use the system feedback signal and modulate the pump speed to regulate the feedback at the Q1-01 setpoint. The units for Q1-01 are selected by b1-01 and the scaling is set in parameter P1-03. This parameter is active when b1-01 (Reference Source) is set to 0 (HOA keypad).

No.	Parameter Name	Setting Range	Default
Q1-01	PID Controller Setpoint 1	0.0 to 6000.0	0.0 PSI

i.7 Troubleshooting



NOTICE

Refer to the iQpump Micro User Manual TOEP YAIQPM 03 for complete information on Troubleshooting causes and solutions.



The iQpump Micro User Manual TOEP YAIQPM 03 is available on the Yaskawa website, www.yaskawa.com.



◆ Fault Detection

■ Fault Displays



Digital Operator Display		Fault Name
LED Operator Display 	LCD Operator Display JVOP-183 	
AJF < >	AJF Anti-Jam Fault	Anti-Jam Fault
bUS	bUS	Option Communication Error • The connection was lost after establishing initial communication. • Only detected when the run command frequency reference is assigned to an option card.
CE	CE	MEMOBUS/Modbus Communication Error Control data was not received for the CE detection time set to H5-09.
CPF02	CPF02	A/D Conversion Error An A/D conversion error or control circuit error occurred.
CPF03	CPF03	PWM Data Error There is a problem with the PWM data.
CPF06 < >	CPF06	EEPROM Memory Data Error Error in the data saved to EEPROM
CPF07	CPF07	Terminal Board Communications Error A communication error occurred at the terminal board.
CPF08	CPF08	EEPROM Serial Communication Fault EEPROM communications are not functioning properly.
CPF11	CPF11	RAM Fault
CPF12	CPF12	FLASH Memory Fault Problem with the ROM (FLASH memory).
CPF13	CPF13	Watchdog Circuit Exception Self-diagnostics problem.
CPF14	CPF14	Control Circuit Fault CPU error (CPU operates incorrectly due to noise, etc.)
CPF16	CPF16	Clock Fault Standard clock error.
CPF17	CPF17	Timing Fault A timing error occurred during an internal process.
CPF18	CPF18	Control Circuit Fault CPU error. Non-Maskable Interrupt (An unusual interrupt was triggered by noise, etc.)
CPF19	CPF19	Control Circuit Fault CPU error (Manual reset due to noise, etc.)
CPF20 or CPF21	CPF20 or CPF21	One of the following faults occurred: RAM fault, FLASH memory error, watchdog circuit exception, clock error

i.7 Troubleshooting

Digital Operator Display		Fault Name
LED Operator Display 	LCD Operator Display JVOP-183 	
CPF22	CPF22	A/D Conversion Fault A/D conversion error.
CPF23	CPF23	PWM Feedback Fault
CPF24 <I>	CPF24	Drive Unit Signal Fault The drive capacity cannot be detected correctly (drive capacity is checked when the drive is powered up).
CPF25	CPF25	Terminal Board Not Connected
CPF26 to CPF35	CPF26 to CPF35	Control Circuit Error
CPF40 to CPF43	CPF40 to CPF43	CPU error
E5	E5	SI-T3 Watchdog Timer Error The watchdog timed out.
EF0	EF0	Option Card External Fault An external fault condition is present.
EF1	EF1	Pump Fault (input terminal S1) External fault at multi-function input terminal S1.
EF2	EF2	Pump Fault (input terminal S2) External fault at multi-function input terminal S2.
EF3	EF3	Pump Fault (input terminal S3) External fault at multi-function input terminal S3.
EF4	EF4	Pump Fault (input terminal S4) External fault at multi-function input terminal S4.
EF5	EF5	Pump Fault (input terminal S5) External fault at multi-function input terminal S5.
EF6	EF6	Pump Fault (input terminal S6) External fault at multi-function input terminal S6.
EF7	EF7	Pump Fault (input terminal S7) External fault at multi-function input terminal S7.
Err	Err	EEPROM Write Error Data cannot be written to the EEPROM
FAn	FAn	Internal Cooling Fan Failure
Fdb-L	FDBKL Wire Break	PID Feedback Loss The analog input programmed for PID feedback has risen above 21 mA or fallen below 3 mA.
GF	GF	Ground Fault <ul style="list-style-type: none"> A current short to ground exceeded 50% of rated current on the output side of the drive. Setting L8-09 to 1 enables ground fault detection in models 2V0020 to 2V0069 and 4V0011 to 4V0038.
Hfb	HFB	High Feedback The feedback signal is too high.
HIH20	HWL	High Water Level The "High Water Level" digital input is active (HI-0□ = 90).

Digital Operator Display		Fault Name
LED Operator Display 	LCD Operator Display JVOP-183 	
LF	LF	Output Phase Loss <ul style="list-style-type: none"> Phase loss on the output side of the drive. Setting L8-07 to 1 or 2 enables Phase Loss Detection.
LF2	LF2	Output Current Imbalance One or more of the phases in the output current are lost.
LFb	LFB	Low Feedback The feedback signal is too low.
LoP	LOP	Loss of Prime The pump has lost its prime.
LoH20	LWL	Low Water Level The "Low Water Level" digital input is active (H1-0□ = 8F).
nSL	MSL Net Master Loss	Net Master Lost The MEMOBUS master has been lost
notS	NMS	Not Maintaining Setpoint The setpoint cannot be maintained and P1-17 is set to 0.
nSE	nSE	Node Setup Error A terminal assigned to the node setup function closed during run.
oC	oC	Overcurrent Drive sensors detected an output current greater than the specified overcurrent level.
oFA00 </>	oFA00	Option Card Connection Error at Option Port CN5 Option compatibility error
oFA01	oFA01	Option Card Fault at Option Port CN5 Option not properly connected
oFA03 oFA04	oFA03 oFA04	Option Card Error Occurred at Option Port CN5
oFA30 to oFA43	oFA30 to oFA43	Communication Option Card Connection Error (CN5)
oH	oH	Heatsink Overheat The heatsink temperature exceeded the overheat pre-alarm level set to L8-02.
oH1	oH1	Overheat 1 (Heatsink Overheat) The heatsink temperature exceeded the drive overheat level.
oH4	oH4	Motor Overheat Fault (PTC Input) <ul style="list-style-type: none"> The motor overheat signal to analog input terminal A1 or A2 exceeded the fault detection level. Detection requires setting multi-function analog inputs H3-02 or H3-10 to E.
oL1	oL1	Motor Overload The electronic motor overload protection tripped
oL2	oL2	Drive Overload The thermal sensor of the drive triggered overload protection.
oL3	oL3	Overtorque Detection 1 The current has exceeded the value set for Torque Detection Level 1 (L6-02) for longer than the allowable time (L6-03).
oL4	oL4	Overtorque Detection 2 The current has exceeded the value set for Torque Detection Level 2 (L6-05) for longer than the allowable time (L6-06).
oL5	oL5	Mechanical Weakening Detection 1 Overtorque occurred, matching the conditions specified in L6-08.

i.7 Troubleshooting

Digital Operator Display		Fault Name
LED Operator Display 	LCD Operator Display JVOP-183 	
oPr	oPr	External Operator Connection Fault The external operator has been disconnected from the drive. Note: An oPr fault will occur when all of the following conditions are true: <ul style="list-style-type: none"> • Output is interrupted when the keypad is disconnected (o2-06 = 1). • The Run command is assigned to the operator (b1-02 = 0 and HAND has been selected).
ou	ov	Overvoltage Voltage in the DC bus has exceeded the overvoltage detection level. <ul style="list-style-type: none"> • For 200 V class drives: approximately 410 V • For 400 V class drives: approximately 820 V (740 V when E1-01 is less than 400)
PF	PF	Input Phase Loss Drive input power has an open phase or has a large imbalance of voltage between phases. Detected when L8-05 is set 1 (enabled).
PoC	PoC	Pump Over Cycle
rH	rH	Braking Resistor Overheat Braking resistor protection was triggered. Fault detection is enabled when L8-01 = 1 (disabled as a default).
rr	rr	Dynamic Braking Transistor The built-in dynamic braking transistor failed.
SC	SC	IGBT Short Circuit or Ground Fault
SEr	SEr	Too Many Speed Search Restarts The number of Speed Search restarts exceeded the value set to b3-19.
IPH	Single Phase Foldback	Single Phase Foldback Output speed is being limited because of excessive DC Bus voltage ripple.
t IE	TIE	Time Interval Error
UL3	UL3	Undertorque Detection 1 The current has fallen below the minimum value set for Torque Detection Level 1 (L6-02) for longer than the allowable time (L6-03).
UL4	UL4	Undertorque Detection 2 The current has fallen below the minimum value set for Torque Detection Level 2 (L6-05) for longer than the allowable time (L6-06).
UL6	UL6 Underload Det. 6	Motor Underload The load has fallen below the underload curve defined in L6-14.
Uu1 <1>	Uu1 <1>	Control Circuit Undervoltage Fault One of the following conditions occurred while the drive was running: <ul style="list-style-type: none"> • Voltage in the DC bus fell below the undervoltage detection level (L2-05). • For 200 V class: approximately 190 V (160 V for single phase drives) • For 400 V class: approximately 380 V (350 V when E1-01 is less than 400) The fault is output only if L2-01 = 0 or L2-01 = 1 and the DC bus voltage is under L2-05 for longer than L2-02. The fault is output only if L2-01 is set to 0 or 1 and the DC bus voltage has fallen below the level set to L2-05 for longer than the time set to L2-02.
Uu2 <1>	Uu2 <1>	Control Power Supply Voltage Fault Voltage is too low for the control drive input power.
Uu3 <1>	Uu3 <1>	Undervoltage 3 (Soft-Charge Bypass Relay Fault) The soft-charge bypass relay failed.
uLts	ULTS	Volute-Thermostat Fault



<1> Fault history is not kept for this fault.

◆ Alarm Detection



■ Alarm Codes



An alarm is indicated by a code on the data display and the flashing ALM LED. The drive output is not necessarily switched off.

To remove an alarm, trace and remove the cause, and reset the drive by pushing the Reset key on the operator or cycle the power supply.



Digital Operator Display		Alarm Name
LED Operator Display 	LCD Operator Display JVOP-183 	
<i>AEr</i>	<i>AEr</i>	Station Address Setting Error (CC-Link, CANopen, MECHATROLINK) Option card node address is outside of the acceptable setting range.
<i>AbFL</i>	AnalogFB lost Switched to Net	Analog Feedback Lost Analog feedback has not been detected and the network PI feedback signal is now used.
<i>AJA</i>	Anti-Jam Active	Anti-Jam Alarm
<i>bAt</i>	<i>bAT</i>	Digital Operator Battery Voltage Low
<i>bb</i>	<i>bb</i>	Baseblock Drive output interrupted as indicated by an external baseblock signal.
<i>bUS</i>	<i>bUS</i>	Option Communication Error <ul style="list-style-type: none"> The connection was lost after establishing initial communication. Only detected when the run command frequency reference is assigned to an option card.
<i>CALL</i>	<i>CALL</i>	Serial Communication Transmission Error Communication has not yet been established.
<i>CE</i>	<i>CE</i>	MEMOBUS/Modbus Communication Error Control data was not received for the CE detection time set to H5-09.
<i>CrSt</i>	<i>CrST</i>	Cannot Reset
<i>CyC</i>	<i>CyC</i>	MECHATROLINK Comm. Cycle Setting Error Comm. Cycle Setting Error was detected.
<i>dnE</i>	<i>dnE</i>	Drive Disabled
<i>E5</i>	<i>E5</i>	SI-T3 Watchdog Timer Error The watchdog timed out.
<i>EF</i>	<i>EF</i>	Forward/Reverse Run Command Input Error Both forward run and reverse run closed simultaneously for longer than 0.5 s.
<i>EF0</i>	<i>EF0</i>	Option Card External Fault An external fault condition is present.
<i>EF1</i>	<i>EF1</i>	Pump Fault (input terminal S1) External fault at multi-function input terminal S1.
<i>EF2</i>	<i>EF2</i>	Pump Fault (input terminal S2) External fault at multi-function input terminal S2.
<i>EF3</i>	<i>EF3</i>	Pump Fault (input terminal S3) External fault at multi-function input terminal S3.
<i>EF4</i>	<i>EF4</i>	Pump Fault (input terminal S4) External fault at multi-function input terminal S4.
<i>EF5</i>	<i>EF5</i>	Pump Fault (input terminal S5) External fault at multi-function input terminal S5.
<i>EF6</i>	<i>EF6</i>	Pump Fault (input terminal S6) External fault at multi-function input terminal S6.

i.7 Troubleshooting

Digital Operator Display		Alarm Name
LED Operator Display 	LCD Operator Display JVOP-183 	
EF7	EF7	Pump Fault (input terminal S7) External fault at multi-function input terminal S7.
EoF	EoF	Emergency Override Forward Run
Eor	Eor	Emergency Override Reverse Run
FAn	FAn	Internal Cooling Fan Error
Hbb	Hbb	Safe Disable Signal Input Both Safe Disable Input channels are open.
HbbF	HbbF	Safe Disable Signal Input One Safe Disable channel is open while the other channel is closed.
FLGt	Feedback Loss Go To Freq. b5-13	PI Feedback Loss The drive will run at the speed set in b5-13, Feedback Loss Goto Frequency.
Fdb-L	Feedback Loss Wire Break	PI Feedback Loss The analog input programmed for PID feedback has gone above 21 mA or fallen below 3 mA.
PFrEF	Freq. Ref PUMP Min (P1-06)	Minimum Pump Frequency Reference Drive frequency reference is set lower than P1-06, Minimum Pump Frequency.
PtHrE	Freq. Ref Thrust (P4-12)	Thrust Frequency Reference The fixed frequency reference is set to a value lower than the P4-12, Thrust Frequency, setting.
HCA	HCA	Current Alarm Drive current exceeded overcurrent warning level (150% of the rated current).
HIFb	High Feedback High FB Sensed	High Feedback Level Alarm The feedback signal is too high.
LoP	LoP	Loss of Prime The pump has lost its prime and P1-22 is set to 1.
LCP	Low City Pressure	Low City Pressure
LoFb	Low Feedback Low FB Sensed	Low Feedback Level Alarm The feedback signal is too low.
LSP	Low Suction Pressure	Low Suction Pressure
LUt	Low Water in Tank	Low Water in Tank
LT-1	LT-1	Cooling Fan Maintenance Time The cooling fan has reached its expected maintenance period and may need to be replaced. Note: An alarm output (H2-□□ = 10) will only be triggered if both (H2-□□ = 2F and H2-□□ = 10) are set.
LT-2	LT-2	Capacitor Maintenance Time The main circuit and control circuit capacitors are nearing the end of their expected performance life. Note: An alarm output (H2-□□ = 10) will only be triggered if H2-□□ = 2F.
LT-3	LT-3	Soft Charge Bypass Relay Maintenance Time The DC bus soft charge relay is nearing the end of its expected performance life. Note: An alarm output (H2-□□ = 10) will only be triggered if H2-□□ = 2F.
LT-4	LT-4	IGBT Maintenance Time (50%) IGBTs have reached 50% of their expected performance life. Note: An alarm output (H2-□□ = 10) will only be triggered if H2-□□ = 2F.

Digital Operator Display		Alarm Name
LED Operator Display 	LCD Operator Display JVOP-183 	
nEt5C	NETSCAN Waiting for Master	NETSCAN Drive is waiting for a message from the master.
not5P	HMS	Not Maintaining Setpoint The setpoint cannot be maintained and P1-17 is set to 1.
oH	oH	Heatsink Overheat The temperature of the heatsink exceeded the overheat pre-alarm level set to L8-02.
oH2	oH2	Heatsink Overheat Warning “Heatsink Overheat Warning” was input to a multi-function input terminal, S1 through S7 (H1-□□ = B).
oH3	oH3	Motor Overheat The motor overheat signal entered to a multi-function analog input terminal exceeded the alarm level (H3-02 or H3-10 = E).
oL1	oL1	Motor Overload The electronic motor overload protection tripped
oL2	oL2	Drive Overload The thermal sensor of the drive triggered overload protection.
oL3	oL3	Overtorque Detection 1 The current has exceeded the value set for Torque Detection Level 1 (L6-02) for longer than the allowable time (L6-03).
oL4	oL4	Overtorque Detection 2 The current has exceeded the value set for Torque Detection Level 2 (L6-05) for longer than the allowable time (L6-06).
ov	ov	Control Circuit Overvoltage Voltage in the control circuit exceeded the trip point. • For 200 V class drives: approximately 410 V • For 400 V class drives: approximately 820 V (740 V when E1-01 < 400)
PCyC	PCyC	Pump Over Cycle
rdd	R-DNE-S□	Remote Drive Disable
SE	SE	MEMOBUS/Modbus Communication Test Mode Error Note: This alarm will not trigger a multi-function output terminal that is set for alarm output (H2-□□ = 10).
TdE	TdE	Time Data Error
TrPC	TrPC	IGBT Maintenance Time (90%) IGBTs have reached 90% of their expected performance life.
UL3	UL3	Undertorque Detection 1 The current has fallen below the minimum value set for Torque Detection Level 1 (L6-02) for longer than the allowable time (L6-03).
UL4	UL4	Undertorque Detection 2 The current has fallen below the minimum value set for Torque Detection Level 2 (L6-05) for longer than the allowable time (L6-06).
UL6	UL6 Underload Det. 6	Motor Underload The load has fallen below the underload curve defined in L6-14.

i.7 Troubleshooting



Digital Operator Display		Alarm Name
LED Operator Display 	LCD Operator Display JVOP-183 	
Uu	Uv	Control Circuit Undervoltage One of the following conditions occurred: <ul style="list-style-type: none"> • Contactor to suppress inrush current in the drive was opened. • Low voltage in the control drive input power. This alarm outputs only if L2-01 is not 0 and DC bus voltage is under L2-05.

◆ Operator Programming Errors

■ oPE Codes

An Operator Programming Error (oPE) occurs when a contradictory parameter is set or an individual parameter is set to an inappropriate value.

The drive will not operate until the parameter or parameters causing the problem are set correctly. An oPE, however, does not trigger an alarm or fault output. When an oPE appears on the operator display, press the ENTER button to view U1-18 and see which parameter is causing the oPE.



Digital Operator Display		Error Name
LED Operator Display 	LCD Operator Display JVOP-183 	
oPE01	oPE01	Drive Capacity Setting Fault Drive capacity and the value set to o2-04 do not match.
oPE02	oPE02	Parameter Range Setting Error Use U1-18 to find parameters set outside the range.
oPE03	oPE03	Multi-Function Input Selection Error A contradictory setting is assigned to multi-function contact inputs H1-01 to H1-07.
oPE04	oPE04	Initialization Required, Term <-> Ctrl Chg
oPE05	oPE05	Run Command/Frequency Reference Source Selection Error
oPE07	oPE07	Multi-Function Analog Input Selection Error A contradictory setting is assigned to multi-function analog inputs H3-02 or H3-06 and PID functions conflict.
oPE08	oPE08	Parameter Selection Error A function has been set that cannot be used in the motor control method selected.
oPE09	oPE09	PID Control Selection Fault PID control function selection is incorrect. Requires that PID control is enabled (b5-01 = 1).
oPE10	oPE10	V/f Data Setting Error One of the following setting errors has occurred: E1-09 ≤ E1-07 < E1-06 ≤ E1-11 ≤ E1-04
oPE11	oPE11	Carrier Frequency Setting Error Correct the setting for the carrier frequency.
oPE33	oPE33 Net Incompatible	Parameter selection is incompatible with the selected network P9-99

◆ Digital Operator Display Messages





Table i.24 lists messages and errors that may appear during normal pump operation.

These messages do not trigger multi-function output terminals that have been set up to close when a fault or alarm occurs.

Table i.24 Digital Operator Display Messages

Digital Operator Display		Description
LED Operator Display 	LCD Operator Display JVOP-183 	
CrSt	CrST Cannot Reset	Fault reset was being executed when a Run command was entered. Ensure that a Run command cannot be entered from the external terminals or option during fault reset. Turn off the Run command.
CUr	Current Limit Foldback	Displayed when drive output speed is being limited due to the output current limit. Reduce the load or replace with higher capacity drive.
dStGE	De-staging in X sec	Displayed during multiplexing when drive de-staging is in progress. X sec indicates the time left before the de-staging takes place.
(no indication)	DigitalOut Delay Active	Displayed when the Digital Output Delay function is active.
FbCH	Feedback Drop Check	Displayed when the drive is determining whether the feedback will change abruptly when the drive enters Sleep Mode. Drop Level is configured by P2-08, Delta Sleep Feedback Drop Level, and P2-09 Feedback Detection Drop Time.
LoC-P	LOCK Parameter Locked	Displayed after an attempt to change a parameter when A1-01 = 3. Unlock the keypad by setting A1-01 = 2.
(no indication)	Lube PUMP Active	Displayed when the Lube Pump digital output is energized.
nEEEr	Net Pump Err Chk Faulted PUMP	Displayed when the drive has been stopped because another drive in the network has a system fault or a Low City Pressure alarm.
nEESt	Net Start Delay P9-29 Active	Displayed when the MEMOBUS network is waiting for the P9-29 timer to elapse.
nEEFb	Network FB Lost Check FB Source	Displayed when no valid analog PI feedback source can be found on the network and network PI feedback has been lost.
PASS	PASS MEMOBUS/Modbus Comm. Test Mode Complete	MEMOBUS/Modbus test has finished normally.
PrCHG	Pre Chg Mode Exit in Xsec	Pre-charge 1 or 2 active. X indicates time left before pre-charge exits due to timers (P4-03 + P4-07).
IPH	Single Phase Foldback	Displayed when an input phase has been lost, or when excess load is being drawn by the motor in a single phase application.
SLEEP	Sleep Active Wait for Start	Displayed when the drive is in Sleep Mode or when the drive is waiting for the feedback level to reach the level set in P1-04, Start Level.
booSt	Sleep Boost Active	Displayed when the drive entering Sleep Mode and the pressure setpoint is being boosted. During this time, the U1-01, Frequency Reference, monitor will be updated with the boosted setpoint.
StAGE	Staging in X sec	Displayed during multiplexing when drive staging is in progress. X sec indicates the time left before the staging takes place.
UJA It	Start Delay Adjust b1-11	Displayed when the drive start is being delayed by Coast to Stop with Timer (Back Spin Timer). This time is adjusted by parameter b1-11, Coast to Stop with Timer Time.
UJA It	Start Delay Timer Active	Displayed when the feedback level has reached the level set in P1-04, Start Level, and the Start Delay timer is incrementing.
tHrSt	Thrust Mode Thrust Active	Displayed during Thrust Mode.
Ut IL	Utility Delay Adjust by P4-17	Displayed when the drive is delaying the Run command due to the Utility Start Delay Function.

◆ Fault Reset Methods

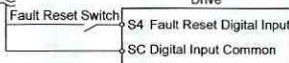
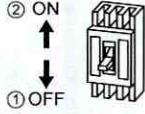
After the Fault Occurs	Procedure	
Fix the cause of the fault, restart the drive, and reset the fault	Press  on the digital operator.	
	Press  on the optional HOA keypad.	
Fix the cause of the fault and reset via Fault Reset Digital Input S4.	Close then open the fault signal digital input via terminal S4. S4 is set to fault reset as default (H1-04 = 12). 	
Turn off the main power supply if the above methods do not reset the fault. Reapply power after the digital operator display has turned off.		

i.8 Drive Specifications

Note: For optimum performance life of the drive, install the drive in an environment that meets the required specifications.

	Item	Specification
Control Characteristics	Control Method	V/f Control (V/f)
	Frequency Control Range	0.01 to 400 Hz
	Frequency Accuracy	Digital input: within $\pm 0.01\%$ of the max output frequency (-10 to +50 °C) Analog input: within $\pm 0.5\%$ of the max output frequency (25 °C ± 10 °C)
	Frequency Setting Resolution	Digital inputs: 0.01 Hz Analog inputs: 1/1000 of maximum output frequency
	Output Frequency Calculation Resolution	$1/2^{20}$ x Maximum output frequency (E1-04)
	Frequency Setting Signal	Main frequency reference: 0 to +10 Vdc (20 k Ω), 4 to 20 mA (250 Ω), 0 to 20 mA (250 Ω) Main speed reference: Pulse Train Input (max 32 kHz)
	Starting Torque	V/f: 150% at 3 Hz
	Speed Control Range	1:40 (V/f Control)
	Accel/Decel Time	0.00 to 6000.0 s (allows four separate settings for accel and decel)
	Braking Torque	Instantaneous Average Decel Torque $\langle \triangleright \rangle$: 0.1/0.2 kW: over 150%, 0.4/0.75 kW: over 100%, 1.5 kW: over 50%, 2.2 kW and above: over 20% Continuous Regen Torque: 20%, 125% with a Braking Resistor Unit $\langle \triangleright \rangle$: (10% ED) 10 s with an internal braking resistor.
	V/f Characteristics	Preset V/f patterns and user-set program available.
Protection Functions	Functions	Momentary Power Loss Ride-Thru Speed Search Over/Undertorque Detection Multi-Step Speed (17 steps max) Accel/Decel Time Switch S-Curve Accel/Decel, 2-Wire/3-Wire Sequence Stationary Auto-Tuning of Line-to-Line Resistance Dwell Cooling Fan ON/OFF Slip Compensation Torque Compensation Jump Frequencies (reference dead band) Frequency Reference Upper/Lower Limit DC Injection Braking (start and stop) PID Control (with Sleep Function) MEMOBUS/Modbus (RS-485/RS-422 Max 115.2 kbps) Fault Reset Parameter Copy Fault Restart Removable Terminals with Parameter Backup Function
	Motor Protection	Motor overheat protection via output current sensor
	Overcurrent Protection	Drives stops when output exceeds 170% of the rated current
	Overload Protection	Drive stops when output current is 120% rated current for 60 sec. $\langle \triangleright \rangle$
	Overvoltage Specification	200 V Class: Stops when DC bus voltage exceeds approx. 410 V 400 V Class: Stops when DC bus voltage exceeds approx. 820 V
	Low Voltage Protection	Drive stops when DC bus voltage falls below the levels indicated: 190 V (3-phase 200 V), 160 V (single-phase 200 V), 380 V (3-phase 400 V), 350 V (3-phase 380 V)
	Momentary Power Loss Ride-Thru	3 selections available: Ride-Thru disabled (stops after 15 ms), time base of 0.5 s, and continue running as long as the drive control board is powered up. $\langle \triangleright \rangle$

i.8 Drive Specifications

Item		Specification
Protection Functions	Heatsink Overheat Protection	Protected by thermistor
	Braking Resistor Overheat Protection	Overheat input signal for braking resistor (Optional ERF-type, 3% ED)
	Stall Prevention	Stall prevention is available during acceleration, deceleration, and during run. Separate settings for each type of stall prevention determine the current level at which stall prevention is triggered.
	Cooling Fan Failure Protection	Circuit protection ("fan-lock" sensor)
	Ground Fault Protection	Electronic circuit protection <5>
	DC Bus Charge LED	Remains lit until DC bus voltage falls below 50 V
Environment	Storage/Installation Area	Indoors
	Ambient Temperature	IP20/NEMA 1, UL Type 1 enclosure: -10 °C to +40 °C (14 °F to 104 °F) IP66/NEMA 4X, UL Type 4X enclosure: -10 °C to +40 °C (14 °F to 104 °F)
	Humidity	95% RH or less with no condensation
	Storage Temperature	-20 to +60 °C (-4 to +140 °F) allowed for short-term transport of the product
	Altitude	Up to 1000 meters without derating; up to 3000 meters with output current and voltage derating.
	Shock, Impact	10 to 20 Hz: 9.8 m/s ² 20 to 55 Hz: 5.9 m/s ²
	Surrounding Area	Install the drive in an area free from: <ul style="list-style-type: none"> oil mist and dust metal shavings, oil, water or other foreign materials radioactive materials combustible materials (e.g., wood) harmful gases and liquids excessive vibration chlorides direct sunlight For IP66/NEMA 4X, UL Type 4X enclosure drives, install the drive in an environment suitable for IP66/NEMA 4X, UL Type 4X enclosures: <ul style="list-style-type: none"> NEMA 4X, UL Type 4X – Enclosures constructed for either indoor or outdoor use to provide a degree of protection to personnel against incidental contact with the enclosed equipment; to provide a degree of protection against falling dirt, rain, sleet, snow, windblown dust, splashing water, hose-directed water, and corrosion; and that will be undamaged by the external formation of ice on the enclosure. IP66 – Dust-tight enclosures to not allow any dust to penetrate. The enclosure guards the drive against powerful jetting water sprayed from any direction and is protected against access to hazardous parts with a wire.
	Orientation	Install the drive vertically to maintain maximum cooling effects
Standards	cULus	
Protective Enclosure	IP20/NEMA 1, UL Type 1 IP66/NEMA 4X, UL Type 4X	
Cooling Method	BV0006F: self-cooled BV0010F to BV0018F: cooling fan 2V0006F to 2V0069F: cooling fan 4V0002F to 4V0004F: self-cooled 4V0005F to 4V0038F: cooling fan	BV0006G and BV0010G: self-cooled BV0012G: internal cooling fan 2V0006G to 2V0012G: self-cooled 2V0020G: internal cooling fan 2V0030G to 2V0069G: internal and external cooling fans 4V0002G to 4V0005G: self-cooled 4V0007G to 4V0011G: internal cooling fan 4V0018G to 4V0038G: internal and external cooling fans

- <1> Instantaneous average deceleration torque refers to the torque required to decelerate the motor (uncoupled from the load) from the rated motor speed down to zero in the shortest time.
- <2> Ensure that Stall Prevention Selection during Deceleration is disabled (L3-04 = 0) or set to 3 when using a braking resistor or the Braking Resistor Unit. The default setting for the stall prevention function will interfere with the braking resistor.
- <3> Overload protection may be triggered when operating with 150% of the rated output current if the output frequency is less than 6 Hz.
- <4> A Momentary Power Loss Ride-Thru Unit is required for 200/400 V class drives 7.5 kW and less if the application needs to continue running during a momentary power loss up to 2 seconds.
- <5> Ground protection cannot be provided under the following circumstances when a ground fault is likely in the motor windings during run: Low ground resistance for the motor cable and terminal block; low ground resistance for the motor cable and terminal block; or the drive is powered up from a ground short.

◆ Single-Phase Derating

iQpump Micro drives are compatible for use with both three-phase and single-phase input power supplies. The drive output to the motor is always three-phase, regardless of number of input phases.

Output capacity to the motor is derated when using single-phase input power and the drive firmware includes protection for single-phase input applications. This protection is enabled by default. Disabling this protection for single-phase input applications can void warranty and result in premature failure.

Selection of larger models always results in greater output capacity to the motor when supplying the drive with three-phase input power. However, the selection of larger models does not always yield greater output capacity when using the drive with single-phase input power.

Several factors affect the amount of derated drive output capacity when single-phase input power is supplied to the drive:

- Single-phase input voltage level
- Motor voltage rating
- Amount of input impedance.

The tables in this section assist in model selection by considering factors that affect the amount of derating in single-phase input power applications.

■ Single-Phase Input Sizing

The rated output current listed in the tables allows for a 120% overload for 60 seconds. Contact Yaskawa if assistance is needed in selecting drive models with higher overload requirements. Adding more impedance than is specified will degrade performance.

Table i.25 240 V Single-Phase Input (-5% to +10%)

Drive Model	Without Input Reactor			Yaskawa Reactor Part Number	With Input Reactor		
	Rated Input Current (A)	Rated Output Current (A)	Max Applicable Motor (HP)		Rated Input Current (A)	Rated Output Current (A)	Max Applicable Motor (HP)
2V0006	7.3	4.9	1.0	URX000303	7.3	4.9	1.0
2V0010	10.8	6.8	1.5	URX000307	10.8	6.8	1.5
2V0012	13.9	7.5	2.0	URX000311	13.9	7.5	2.0
2V0020	24.0	9.7	2.0	URX000319	24.0	12.3	3.0
2V0030	37.0	7.5	2.0	URX000326	37.0	15.2	3.0
2V0040	52.0	16.7	5.0	URX000329	52.0	21.0	5.0
2V0056	68.0	23.4	5.0	URX000335	68.0	27.7	7.5
2V0069	80.0	25.8	7.5	URX000335	80.0	30.8	10.0

Table i.26 480 V Single-Phase Input (-5% to +10%)

Drive Model	Without Input Reactor			Yaskawa Reactor Part Number	With Input Reactor		
	Rated Input Current (A)	Rated Output Current (A)	Max Applicable Motor (HP)		Rated Input Current (A)	Rated Output Current (A)	Max Applicable Motor (HP)
4V0002	2.1	1.3	0.5	URX000292	2.1	1.7	0.5
4V0004	4.3	2.4	1.0	URX000300	4.3	2.8	1.0
4V0005	5.9	3.5	1.5	URX000304	5.9	3.9	2.0
4V0007	8.1	3.5	1.5	URX000309	8.1	5.4	2.0
4V0009	9.4	5.1	2.0	URX000308	9.4	5.5	3.0
4V0011	14.0	5.5	3.0	URX000312	14.0	7.5	3.0
4V0018	20.0	4.5	2.0	URX000316	20.0	8.7	5.0
4V0023	24.0	5.5	3.0	URX000320	24.0	10.5	5.0
4V0031	38.0	7.9	3.0	URX000327	38.0	13.5	7.5
4V0038	44.0	11.3	5.0	URX000327	44.0	16.1	10.0

i.9 Parameter Table

This parameter table shows the most important parameters. Default settings are in **bold type**. Refer to the User Manual for more detailed descriptions of parameters and settings.

No.	Name	Description	No.	Name	Description
A1-00	Language Selection	0: English 1: Japanese 2: German 3: French 4: Italian 5: Spanish 6: Portuguese 7: Chinese	b1-08	Run Command Selection in Programming Mode	0: Run command is not accepted while in Programming Mode. 1: Run command is accepted while in Programming Mode. 2: Prohibit entering Programming Mode during run.
A1-01	Access Level Selection	0: View and set A1-01 and A1-04. U□-□□ parameters can also be viewed. 1: User Parameters (access to parameters selected by the user, A2-01 to A2-32) 2: Advanced Access (access to view and set all parameters) 3: Lock parameters	b1-11	Run Delay at Stop (Back Spin Timer)	Sets the amount of time that the drive will disallow the reapplication of the Run command after the Run command is lost. b1-11 is active for all b1-03 settings.
A1-03	Initialize Parameters	0: No initialization 1110: User Initialize (parameter values must be stored using parameter a2-03) 2220: 2-Wire initialization 3330: 3-Wire initialization 5550: Terminal->Control Initialize 6008: Pressure Control 6009: Pump down level 7770: General purpose 7771: Submersible motor GP operation	b1-12	Run Delay Memory Selection	0: Disabled 1: Only at Stop 2: Running & Stop Note: A JVOP-183 HOA Keypad must be plugged into the drive for settings 1 and 2 to function. If the keypad is removed, b1-12 will function as setting 0 (Disabled).
A1-04	Password	When the value set into A1-04 does not match the value set into A1-05, parameters A1-01 through A1-03 and A2-01 through A2-33 cannot be changed.	b1-14	Phase Order Selection	0: Standard 1: Switch phase order (reverses the direction of the motor)
A1-05	Password Setting		b1-15	Frequency Reference Selection 2	0: Operator 1: Analog Input 2: Serial Communications 3: Option PCB 4: Pulse Input
A1-06	Application Preset	0: Pressure control 1: General purpose 2: Submersible motor GP operation 8: Pressure control 9: Pump down level Note: This parameter is not settable. It is used as a monitor only.	b1-16	Run Command Selection 2 Run Source 2	0: Operator 1: Digital Inputs 2: Communication 3: Option PCB
A2-01 to A2-32	User Parameters 1 to 32	Recently edited parameters are listed here. The user can also select parameters to appear here for quicker access.	b1-17	Run Command at Power Up	0: Disregarded. A new Run command must be issued after power up. 1: Allowed. Drive will run immediately after power up if a Run command is present.
A2-33	User Parameter Automatic Selection	0: A2-01 to A2-32 are reserved for the user to create a list of User Parameters. 1: Save history of recently viewed parameters. Recently edited parameters will be saved to A2-17 through A2-32 for quicker access.	b2-01	DC Injection Braking Start Frequency	Sets the frequency at which DC Injection Braking starts when "Ramp to stop" (b1-03 = 0) is selected.
b1-01	Frequency Reference Selection 1	0: Operator (will also switch PID setpoint to Q1-01) 1: Analog input terminals 2: MEMOBUS/Modbus communications 3: Option PCB 4: Pulse input (terminal RP)	b2-02	DC Injection Braking Current	Sets the DC Injection Braking current as a percentage of the drive rated current.
b1-02	Run Command Selection 1	0: HOA keypad 1: Digital input terminals 2: MEMOBUS/Modbus communications 3: Option PCB	b2-03	DC Injection Braking Time at Start	Sets DC Injection Braking time at start. Disabled when set to 0.00 seconds.
b1-03	Stopping Method Selection	0: Ramp to stop 1: Coast to stop 2: DC Injection Braking to stop 3: Coast with timer	b2-04	DC Injection Braking Time at Stop	Sets DC Injection Braking time at stop.
b1-04	Reverse Operation Selection	0: Reverse enabled 1: Reverse disabled	b3-01	Speed Search Selection at Start	0: Disabled 1: Enabled
b1-07	Run Command Retention when Source is Changed	0: Require Cycle 1: Retain Run Command	b3-02	Speed Search Deactivation Current	Sets the current level at which the speed is assumed to be detected and Speed Search is ended. Set as a percentage of the drive rated current.
			b3-03	Speed Search Deceleration Time	Sets output frequency reduction time during Speed Search.
			b3-05	Speed Search Delay Time	When using an external contactor on the output side, b3-05 delays executing Speed Search after a momentary power loss to allow time for the contactor to close.
			b3-06	Output Current 1 during Speed Search	Sets the current injected to the motor at the beginning of Speed Estimation Speed Search. Set as a coefficient for the motor rated current.
			b3-08	Current Control Gain during Speed Search (Speed Estimation Type)	Sets the proportional gain for the current controller during Speed Search.